

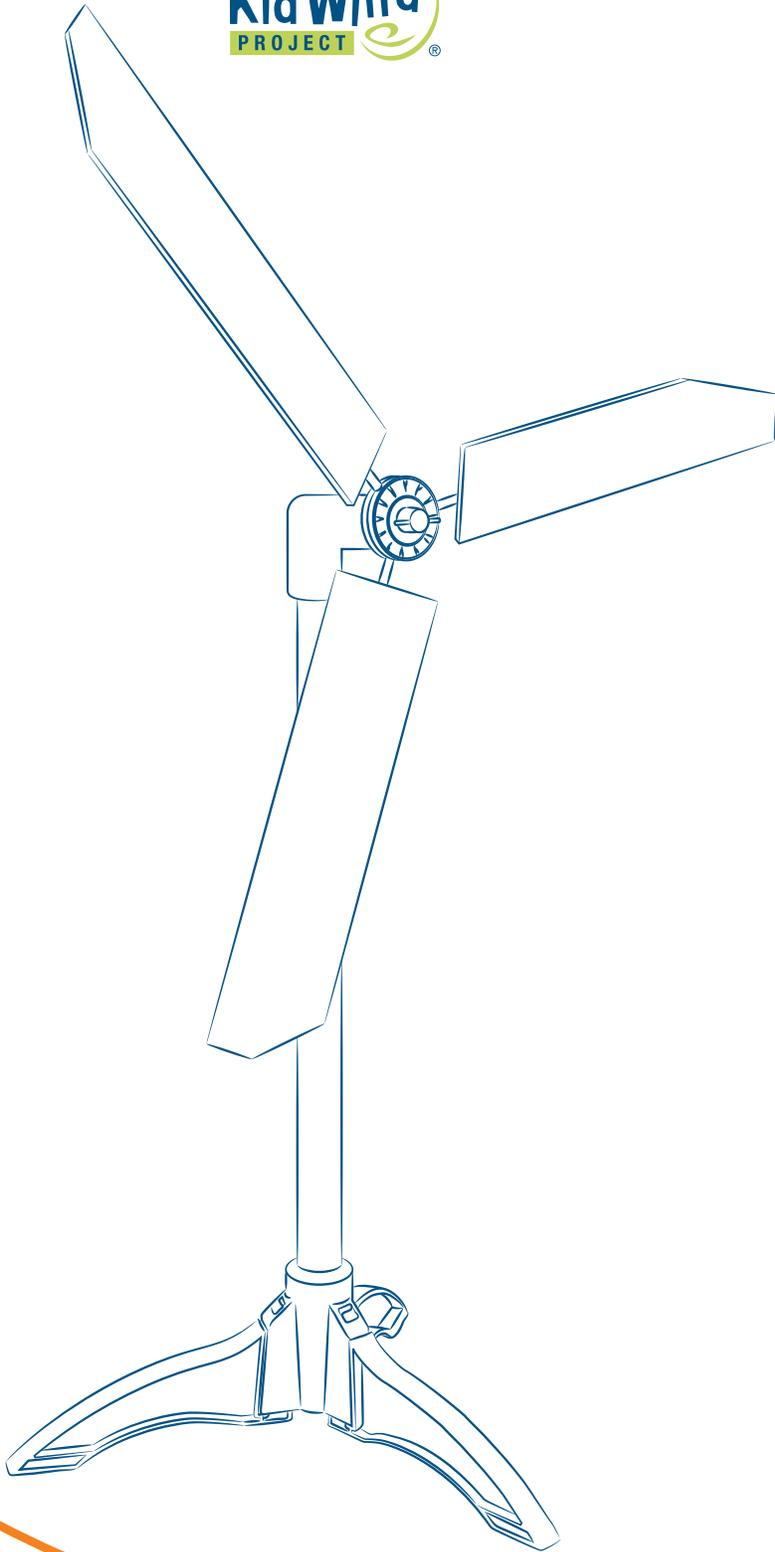

Basic Wind Experiment Kit



instructions

About KidWind

The KidWind Project is a team of teachers, students, engineers, and practitioners exploring the science behind wind energy in classrooms around the US. Our goal is to introduce as many people as possible to the elegance of renewable energy through hands-on science activities which are challenging, engaging, and teach basic science principles.

While improving science education is our main goal, we also aim to help schools become important resources for both students and the general public, to learn about and see renewable energy in action.

Thanks to ...

We would like to thank the Wright Center for Science Education at Tufts University for giving us the time and space to develop this idea into a useful project for thousands of teachers.

We would also like to thank Trudy Forsyth at the National Wind Technology Center and Richard Michaud at the Boston Office of the Department of Energy for having the vision and foresight to help establish the KidWind Project in 2004. Lastly, we would like to thank all the teachers for their keen insight and feedback on making our kits and materials first rate!

Wind for All

At KidWind, we strongly believe that K–12 education is an important foundation for promoting a more robust understanding of the opportunities and challenges that emerging clean energy technologies present.

The Wind for All program seeks to support teachers and students all over the globe who do not have the financial capacity to access our training programs and equipment. We believe that all teachers and students—regardless of where they live or what school they attend—must be part of the clean energy future.

A Note on Reproduction

This work may not be reproduced by mechanical or electronic means without written permission from KidWind, except for educational uses by teachers in a classroom situation or a teacher training workshop. For permission to copy portions or all of this material for other purposes, such as for inclusion in other documents, please contact Michael Arquin at KidWind: michael@KidWind.org



Our plastic components are made from recycled resins.



Made in US

We source domestically whenever possible, and assemble and pack our kits in St. Paul, MN.



Proceeds from your purchase help us train and supply teachers.

This is the next generation of the first wind turbine developed at KidWind. The idea was adapted from a design discovered at www.otherpower.com.

By combining weightlifting and electrical producing turbines, this 2-in-1 kit will allow you to perform a variety of engaging experiments and wind demonstrations.

These instructions will show you how to build this wind turbine, how to make blades for your wind turbine, how to use a multimeter to record electrical data, and will discuss some basic wind energy science.

Cool features of the Basic Wind Experiment Kit

The Basic Wind Experiment Kit is a great introduction to wind energy science and engineering concepts. This is a robust, experimentally rich turbine kit that is appropriate for elementary, middle, and high school students.

Experimentally Rich

- Ability to test electricity production and weightlifting
- Explore torque and energy transfers
- Measure electrical and mechanical power
- Experiment with wind turbine blade design

Renewable

- Forest Stewardship Council (FSC) certified renewable wood tower
- Plastic parts are made from recycled plastic

Use your Basic Wind Experiment Kit to power a variety of load devices:

- LEDs
- Small motors
- Supercapacitors
- Any other small applications that you can think of

Basic Wind Experiment Kit Parts

Nacelle



1 IN. PVC
SLIP CAP



2 IN. HDPE

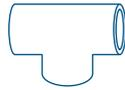

1 IN. PVC
T-FITTING



1 IN. PVC
ELBOW



1 IN. PVC
COUPLER

Blades



BLADE PITCH
PROTRACTOR

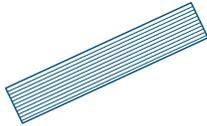

16 IN. CORRUGATED
PLASTIC SHEETS



1/4 IN. DOWELS

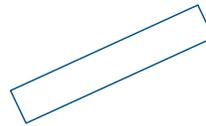

18 IN. Balsa
WOOD SHEETS

Tower



BASE CENTER

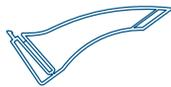

LEGS



TOWER LOCK
DISC

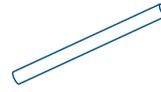

20 IN. WOOD
TOWER

Drivetrains



HUB QUICK CONNECT
& DRIVESHAFT



WIND TURBINE
MOTOR



HEX LOCKS



WIND TURBINE
HUB



SPOOL

Output Devices



LED BULBS



INCANDESCENT BULBS



SUPERCAPACITOR

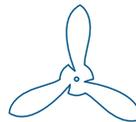

PROPELLER



PLASTIC BUCKET



4 FT. STRING



WASHERS



DIGITAL MULTIMETER



RESISTORS



ALLIGATOR CLIP CORDS



WIND TURBINE
MOTOR

Construction

KidWind tower assembly

The turbine tower is made of six pieces:

- 1 Wood tower
- 1 Center hub
- 1 Locking disk
- 3 Legs

1. Lock one leg onto the center hub.
2. Attach the two other legs in the same way.
3. Slide the locking disk onto the tower about 6 inches from the bottom end.
4. With the teeth of the locking disk pointing down, insert the tower into the center hub.
5. Slide the locking disk down the tower and into the hub, locking the tower in place.

To disassemble the legs, you can use one of your 1/4" dowels as a lever. Insert it into the gap on the leg below the hub and push it away. The leg will pop right off!



CHECK OUT ONLINE VIDEOS FOR HELP!

For help with assembling and disassembling the tower and base, watch a quick video at www.KidWind.org/videos



3



4

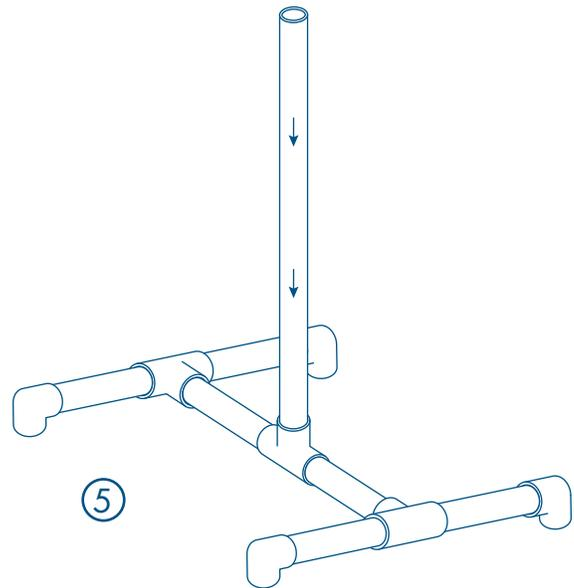
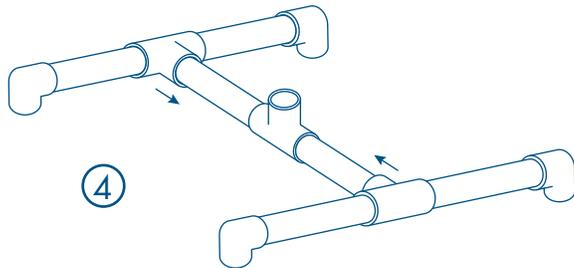
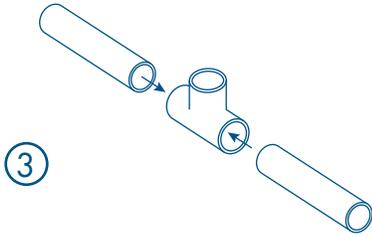
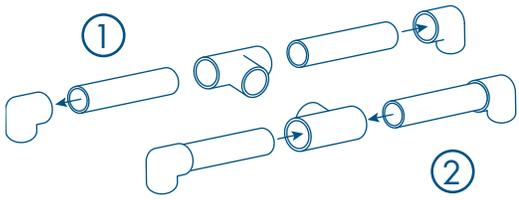

DIY PVC tower

KidWind's first turbines all had towers and bases made from PVC pipe. It's cheap, sturdy and available everywhere. Unfortunately, the production of polyvinyl chloride also results in carcinogens and mutagens, which can also be released if the product is incinerated. In keeping with our commitment to the environment, we are phasing out PVC in our products.

However, we are also committed to making renewable energy science accessible, so we continue to sell affordable DIY kits, which require our customers to build their own tower and base. If you choose to use PVC pipe, follow these instructions to easily build your own.

Parts needed

All PVC is 1" diameter, schedule 40.

- 4 90° PVC fittings
- 6 6" PVC pipe sections
- 3 PVC T-fittings; drill a small hole in one "T"
- 1 24" PVC pipe section

Instructions

1. Insert one 6" piece of PVC into each of the 90° PVC fittings.
2. Use each of the PVC T's as a connector for two of the pieces you constructed in step one. When assembled, the pieces should form a straight line. The open ends of the T's should be positioned parallel to the ground and facing each other.
3. To construct the leg connector portion, insert the two remaining sections of 6" PVC into the remaining PVC T-fitting so that the open end of the T is pointing upwards and the pipes form a straight line.
4. To finish constructing the base of your tower, insert the open pipe ends of the leg connector portion into the open ends of the PVC T-fittings in the leg halves.
5. Finally, insert the 24" PVC pipe into the open and upwards-facing portion of the leg connector's PVC T. Straighten all parts and make sure joints are secure.

Fit the parts together without using glue. (PVC glue is really nasty stuff.) To make them fit snugly, tap them together with a hammer or bang them on the floor once they are assembled.

NO NEED TO GLUE

It is not necessary to glue the joints. PVC glue is nasty stuff. Omitting glue out also lets you take the tower apart for storage.

Building the Electrical Nacelle (Head)

1. Wrap a piece of duct tape around the outside of the generator. This piece of tape should be about ½" wide and 10" long. This will help the generator fit securely into the PVC coupler.
2. For the next step, use 1 PVC 90° elbow, 1 PVC coupler, 1 2" piece of HDPE pipe and the DC generator w/wire.
3. Arrange the pieces as they look in the image to the right. Push them together to form a solid piece. On a large wind turbine this is called a nacelle. It holds the generator, gear boxes, and other equipment.
4. Insert the wires attached to the DC generator through the nacelle. They should come out of the drilled hole at the back of the 90° PVC elbow.
5. Insert the generator into the coupler. It should fit very snugly. Since the generator is pushed frequently by students, it must be *tight*! If it is too tight remove some tape; if it is too loose add some tape.
6. Make sure the motor is straight and not too far in. If it looks crooked, straighten it out. Otherwise it will cause your hub and blades to wobble while spinning.
7. Once the motor is secured, attach the hub. Press the hub onto the generator drive shaft. It should fit very snugly.

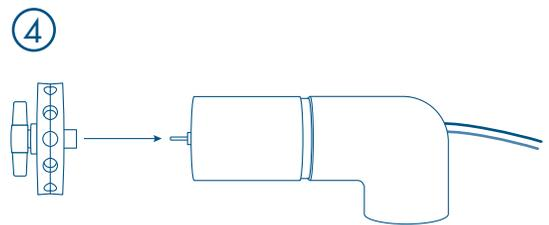
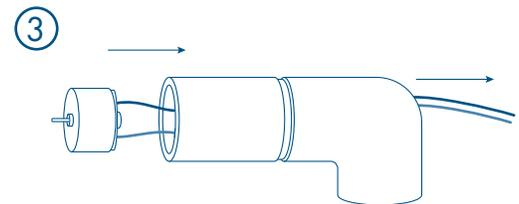
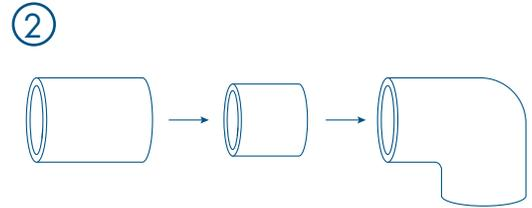
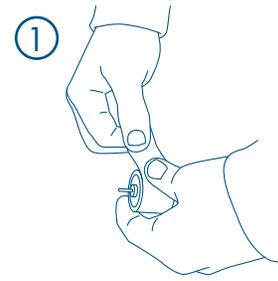

HOW MUCH ELECTRICITY DO THESE DEVICES REQUIRE?

Fuel Cells need 1.5 volts. More than 2.5 volts for a sustained period can damage your fuel cell.

LEDs require at least 2 volts. Polarity is important with LEDs, so if its not working, try reversing the LED.

Our small DC motors need .6-.8 volts.

Our low voltage water pump needs around 2.5 volts.

TAPE WIRES

You may want to tape the wires to your tower so they will not break away from the generator

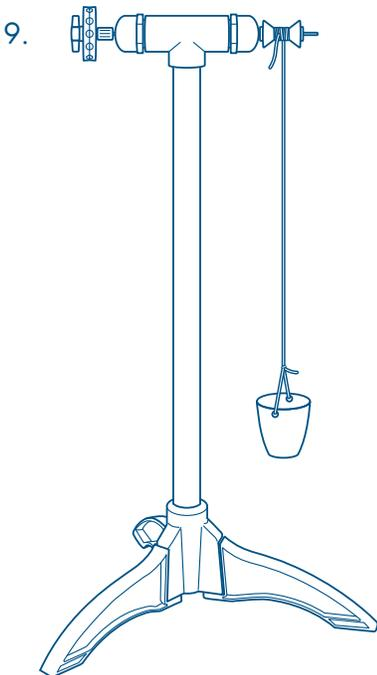
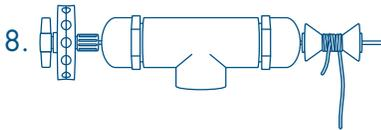
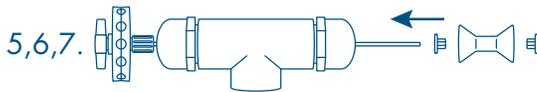
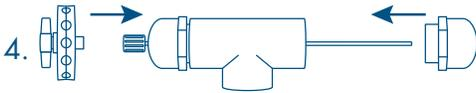
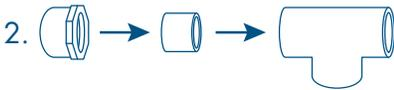

Building the Weightlifter Nacelle (Head)

1. Insert one 2" section of HDPE pipe into each drilled PVC Slip Cap.
2. Insert the other side of one 2" HDPE pipe into one side of a PVC T fitting.
3. Push the steel hex driveshaft through the drilled hole on the PVC Slip Cap. The green Hub Quick-Connect will end up next to the slip cap.
4. Slide the steel driveshaft through the 2" HDPE section and out the drilled hole of the second PVC Slip Cap. Attach the KidWind Crimping Hub to the Hub Quick-Connect.
5. Push one of the hex-locks onto the back of the steel driveshaft. This hex-lock can push down until it is almost touching the PVC Slip Cap. Make sure the flange is facing backwards—as the spool will lock onto this flange.
6. Insert one of the wooden spools behind this pulley. The diameter of your spool will affect the mechanical advantage of your windmill. We will discuss this more later!
7. Push the second green hex-lock behind the wooden spool to secure it in place. This time the flange should face forward to lock into the spool.
8. Tie, tape or glue the string to the wooden spool so that it will wind up when the hub rotates.
9. Attach the other end of the string to the plastic cup. Your weightlifter nacelle is now complete. Time to build some blades!

Multimeter

Using a multimeter, you can quantify the voltage and/or current your turbine is producing. Learning how to accurately measure the voltage and current for a range of situations will help you compare data when testing blades, comparing gearing, or changing any other variables on your ALTurbine. You will also need this information if you want to calculate the amount of power your turbine produces.

Measuring voltage

Attach the wires from the generator to the multimeter. Polarity is not relevant at this point.

To check the voltage, use the dial on the multimeter and select DC volt (V) and set the number to 20.

Place your turbine out in the wind or in front of a fan and let it spin. It is normal for the voltage readings to fluctuate. Voltage output is often unsteady because of unbalanced blades or the inconsistent nature of the wind.

Voltage is related to how fast the DC generator is spinning. The faster it spins, the higher the voltage. When there is no load on the generator, it has little resistance and can spin very fast.

You can measure voltage with no load, but it is more realistic to place a resistor in the circuit and measure the voltage across the resistor. We commonly use 10, 30, 50 or 100 ohm resistors when measuring voltage on KidWind Turbines.

Measuring current

To calculate your turbine's power output, you will need to measure current as well. To collect amperage data, you will need to place a load, preferably a resistor, in series with the multimeter so that the generator is forced to do some work.

When measuring current, you are monitoring how many electrons are being pushed through the wire by the turbine. We measure current from our turbine in milliAmperes. Recall that $1\text{A} = 1000\text{mA}$

Build your circuit with a resistor and then place the multimeter in series. Set the meter to 200 or 20 mA, which is a typical range for our devices. If your turbine produces more amperage, you can turn the dial to a higher range.

The current that your turbine produces depends on the load placed in the circuit and the torque your blades are generating.

Measuring DC Voltage

This meter is measuring 1.5 volts.

Measuring Current

This meter is measuring 11.8 mA.

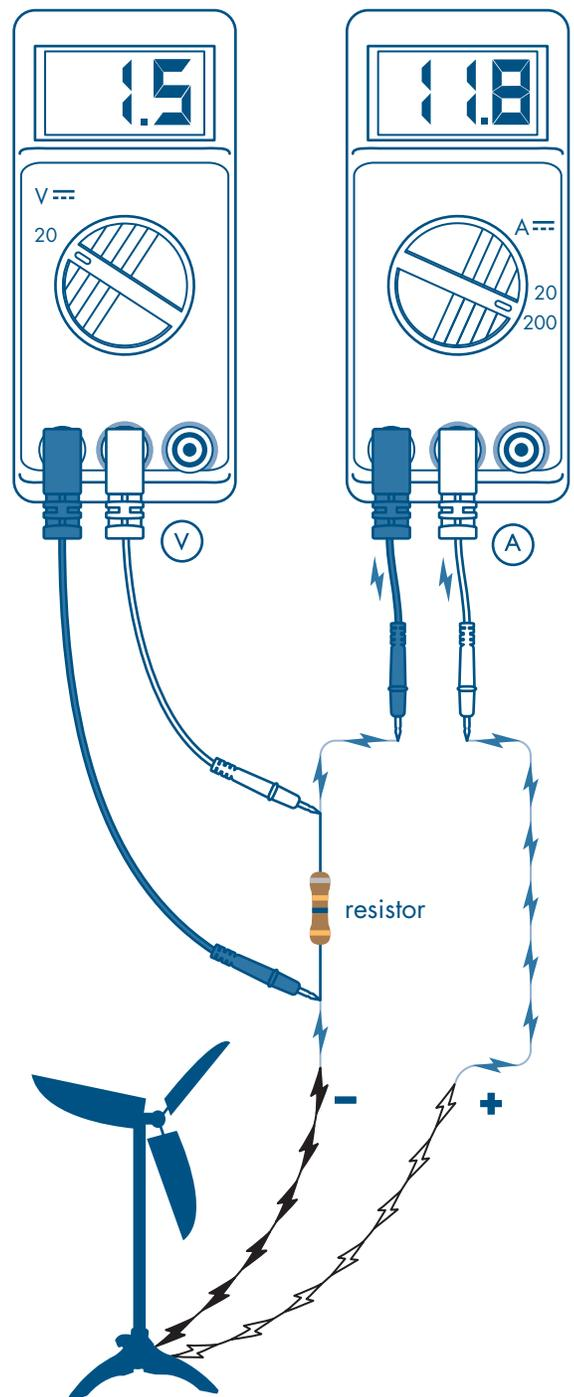

CHECK OUT LEARN WIND!

For more information on using your multimeter—and much more—see the Learn Wind document.

Experiment Ideas

Your Basic Wind Experiment Kit comes with two types of turbines. One nacelle can generate electricity and the other can lift weights. With these two types of turbines you can perform a number of experiments. You can perform these experiments on just one type of turbine or compare how they affect weightlifting and electrical output.

To measure the power output of your weightlifter you can record two values. One way to measure the power output of this turbine is to record the maximum number of washers you can lift in each experiment. For more advanced experiments you should measure how fast it takes to lift a set number of washers. For this type of experiment you will need a stopwatch (ewwach washer weights approximately 13 grams).

To measure the power output of your electrical turbine you will need to record the voltage you produce across the resistor. To see how to do this see page 9.

One thing to keep in mind is that for turbines of the same size (blade diameter) the power we can get out of our wind device is related to how *fast* the blades spin and how much *torque*—or the rotational force they generate.

The simple equation below shows the relationship between these two forces. The most powerful turbine (if we were comparing devices of similar size) is one that has high rotational speed with lots of torque. You will see through experimentation that it can be very difficult to have high speed and torque.

Power output = torque × rotational speed

Below are some basic experiments to get you started exploring. You can use the data collection sheets on pages 14 and 15 to collect your data. We offer some other ideas for experiments at the end of this section.

Experiment with the blade pitch

When the blades are flat against the wind (0°), the air will push the blades in the same direction as the wind. This results in a minimum transfer of energy from the moving air. Likewise, when the blades are 90° , or perpendicular, to the wind, there is no push at all from the moving air since there is very little exposed surface. Half-way between these two extremes, at 45° , some of the force pushes the blade sideways while some force pushes it backwards. Therefore, in principle, an angle of 45° should provide for the maximum push from the wind. Can you tell us if this true?

For this experiment it is important to keep the number of blades constant. You can use your blade pitch measuring tool to easily measure the pitch of your blades. It is *vital* that the pitch of your blades be similar. Measure carefully!

Some ideas:

- What pitch can lift the most weight if you keep the wind speed the same?
- Keep the weight constant in your bucket and only adjust your pitch angle. Measure the time it takes to lift the weight as you change your blade pitch. What blade pitch gives you the most lifting power? Is this the same pitch that can lift the most weight?
- What blade pitch produces the most power on your electrical turbine? Is it the same as on your weightlifter? Why?
- Could you make a twisted blade where the pitch changes as you move down the blade?
- Look at some wind turbine blades to get an idea of twisted pitch.

Experiment with the number of blades

For this experiment it is very important to keep the pitch of the blades constant. It can be easier to start with one or two blades then increase and record power output as you add more blades.

When testing the number of blades on your weightlifter, one strategy is to keep the weight constant while altering the blade number. Then measure the time it takes to lift the weight to determine which blade setup gives you the most power. The faster it lifts the weights the more power you are generating.

Some ideas:

- Is there a relationship between the number of blades and the lifting capacity of the turbine? Will six blades lift twice as much weight as three blades? What amount of blades can lift the most weight?
- How does increasing the numbers of blades affect your electrical power output? Do more blades help you generate more electricity?
- How many blades are optimal on the weightlifter for lifting the maximum amount of weight? How many blades are optimal on the electrical turbine? Are they the same number?
- Is there some point where adding blades makes the wind turbine less efficient in terms of lifting weights or generating electricity?
- Which number of blades seems to generate more turning force (torque)? You can tell by which one lifts the most weight.
- Which blade set seems to be spinning the fastest? You can tell by the one that generates the highest voltage or lifts the weights the fastest.

DETERMINING POLARITY

To determine the proper polarity of your turbine or solar cell, you will need to connect it to a multimeter. If your voltage reading is positive, the lead connected to the red multimeter wire comes from the positive terminal. If the voltage reading is negative, the lead connected to the red multimeter wire comes from the negative terminal. It is a good idea to mark your wires with tape so you know which is positive and which is negative.

Advanced Experiments

Exploring Solidity

Solidity is the ratio of the blade area to total swept area of the turbine. If we know the area of one blade we can easily determine the surface area of all of our blades together.

To determine the swept area of your wind turbine use the formula below to calculate the area of circle. (r = radius of the blade swept area which is the length of one blade).

$$\text{Total swept area} = \pi r^2$$

To calculate the area of your blades you will need to measure them. This is easier if the blades are rectangular in shape.

$$\text{Solidity} = \frac{\text{area of blades}}{\text{total swept area}}$$

A rotor with a solidity of 1 would have the entire swept area filled with a solid disc. This would not work well as blades must let some air past so they can spin.

Some ideas:

- Do the optimal blades for weight lifting and electricity generation have the same or different solidity values?
- What spins faster: high or low solidity turbines?
- What solidity value has the most turning force or torque?
- Research the term *solidity*? What did you learn?

The two pictures to the left show wind devices designed to do two very different things. One is designed to pump water one is designed to generate electricity. Do you have an idea which one is which? Which one has the higher *solidity*?

Experiment with driveshaft diameter (Weightlifter only)

When you change the diameter of the shaft where your string is connected, the mechanical energy required to lift the same amount of weight will change. We can explore how this mechanical energy changes. Keeping the weight and blade setup constant, insert the wooden spool onto the shaft and reattach your weight bucket to the larger diameter.

- Which diameter shaft can lift the most weight?
- Which diameter shaft lifts weights the fastest?

Wind powered machines require different designs for different applications.

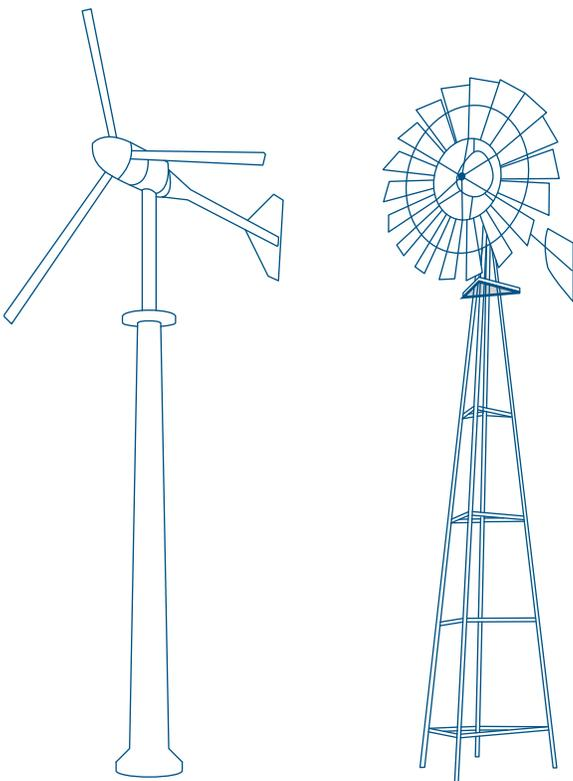

Some other experiments to perform on one turbine or comparing the electrical generator to the weightlifter:

- How does the weight of the blades affect weight lifting or electrical generation?
- How does wind speed affect weight lifting or electrical generation?
- How does the shape of the blades affect weight lifting or electrical generation?
- How do the materials you use to make blades affect weight lifting or electrical generation?

Work, Energy & Power

Work, Power and Energy are important ways to measure how your turbine performs.

Energy (E) can be defined as the capacity for doing work, it is a quantity. The simplest case of mechanical work is when an object is standing still and we force it to move.

Work (W) can be defined as transfer of energy. In physics we say that work is done on an object when you transfer energy to that object.

Work is the application of a force over a distance. Lifting a weight from the ground and putting it on a shelf is a good example of work. The force is equal to the weight of the object, and the distance is equal to the height of the shelf ($W = F \times d$).

Work and Energy are measured in the same units: Joules or N m.

Power (P) is the rate of energy generation (or absorption) over time. It is a rate, similar to miles per hour, gallons per minute, and dollars an hour. $P = E/t$

Power's SI unit of measurement is the watt (W), representing the generation or absorption of energy at the rate of 1 Joule/sec. The unit of power in the English system is the horsepower, equivalent to 735.7 W.

This stuff can get pretty confusing, so take your time as you explore. The point is that power, energy and work are interchangeable when comparing weightlifting and electrical turbine, but how you calculate these output numbers varies. Using these tools you can do a much more detailed analysis of how your wind turbine performs and better compare weightlifting turbines vs. electrical turbines.

EXAMPLE 1: MECHANICAL ENERGY

A KidWind Weightlifter Turbine lifts 100 grams, 60cm in 3 seconds.

How much energy was required to accomplish that task?

Recall:

$$\text{Force} = \text{Mass} \times \text{Acceleration} \quad \text{Acceleration} = 9.8 \text{ m/s}^2$$

$$W = \text{Force} \times \text{Distance}$$

$$W = \text{Mass (kg)} \times \text{Acceleration (m/s}^2) \times \text{Distance (m)}$$

$$W = .100 \text{ kg} \times 9.8 \text{ m/s}^2 \times .6 \text{ m}$$

$$W = .588 \text{ Joules (J)}$$

What was the average power if it took 3 seconds to perform that work?

$$P (W) = E/t$$

$$P (W) = .588/3$$

$$P (W) = .196$$

EXAMPLE 2: ELECTRICAL ENERGY

A KidWind Turbine was steadily producing 3 volts across a 30 ohm resistor over a period of 30 seconds.

Calculate the power output:

$$\text{Power}(W) = V^2/R$$

$$\text{Power (W)} = 32/30$$

$$\text{Power (W)} = .3 \text{ W (Joule/Sec)}$$

Calculate the energy produced:

$$\text{Energy (J)} = P \times t$$

$$\text{Energy (J)} = .3 \text{ W} \times 30 \text{ seconds}$$

$$\text{Energy} = 9 \text{ Joules}$$

Simple Experiments

These experiment pages are designed to help you collect data as you perform experiments on your KidWind Turbine. These data sheets will work for any of the turbines we offer, but be sure to read the questions carefully as the responses may vary.

Testing blades on wind turbines can be challenging. Wind turbine blades have a number of things you can change on them at the same time, so collecting data on *one* variable can be challenging. Take your time and do your experiments with care and things will go fine!

1. What variable are you testing (independent variable)? Circle one:

Blade length Blade pitch Blade shape Windspeed Blade number Blade weight Other

What do you predict will happen as you change your variable? Why? _____

2. Will your turbine be under some kind of load?

Resistor Water pump Light bulb Weights

3. If you are using a resistor, what size are you using? Circle one: 10Ω 30Ω 50Ω 100Ω Other _____

4. What kind of fan are you using? _____

5. What is the diameter? _____ What is the power setting? _____

6. What data are you recording (dependent variable). Circle one:

Voltage Current Power Bolts lifted Water pumped

Data collection

Variable tested	Voltage (volts)	Current (amps)	Power (volts x amps)	Other

Dependent variable
(voltage, current, weight)

Independent variable
(blade length, pitch, etc.)

Results

How did your blade variable affect the output of your turbine? _____

Can you describe why this may be happening? _____

Do you think you could use the data to improve your next set of blades? What would you do to make them perform better?

Troubleshooting

Why won't the rotor spin when I put my turbine in front of the fan?

Check the orientation of the blades. Are your blades oriented in the same direction? Are they flat? Are they hitting the tower? Look at some pictures of windmills to get some ideas about how to orient your blades.

Why does the turbine slow down when I attach it to a load (resistor, pump, bulb, motor)?

Electrical loads all have some resistance. Resistance “resists” the flow of current. This makes it harder to push electrons through the circuit. The more load you add, the harder it is for the generator to turn and the more torque you must generate from the blades. The best ways to do this are to increase blade pitch, make bigger blades, or find stronger wind.

Why are the readings on my multimeter all over the place?

Your readings may be fluctuating because the wind coming out of your fan is fluctuating. This can also be caused by blades that don't spin smoothly or change shape as they spin. Additionally, your readings will be irregular if your blades are not balanced, evenly distributed, or are producing unequal amounts of drag.

Why are the readings on the multimeter *negative*?

The meter is reading the polarity of the wires. As your turbine spins in one direction one wire will be the positive lead the other negative will be the negative lead. If you spin your turbine the other direction the polarity of the wires will be reversed. For LEDs and Fuel Cells hooking up the correct polarity matters—on other items the polarity is not critical.

What are the best blades?

That is for you to figure out! Lots of testing and playing will get you closer to your answer.

Is a fan a good wind source to test with?

Well, it is the best we've got, unless you have a wind tunnel handy! While a fan will make your turbine spin, it is not exactly like the wind outside. The wind that comes out of a fan has a great deal of rotation and turbulence. It isn't very smooth. To see this turbulence, hold a short piece of thread in front of a fan and move it from the center out. It should head out straight all the time. Does it?

Can I take my turbine outside? Can I leave it there?

You can certainly take, use, and test your wind turbine outside. But unless you have a yawing tower (available from KidWind), it will not track the wind and may not perform optimally. To make it work well, you will have to continually face it into the wind. It is not a good idea to leave your turbine outside for too long. It is designed for basic lab tests, not to endure the rigors of the outdoor environment!

Based on the power in the wind equation, it seems that longer blades should make more power. Why isn't this true on my turbine?

The blades on your turbine may be bigger than the diameter of the fan. If that is the case, the extra length is only adding drag so your blades will slow down. Additionally, large blades are designed poorly, they will have lots of drag near the tips and slow down. This will negate any positive effect of the added length. Also, short blades spin faster than long ones, so if you are just recording voltage they will seem better. Try short blades with a load in series and see if they have enough torque to spin. In many cases they do not!

Hex Lock and the Hub Quick Connect

1. The hex-shaped driveshaft allows you connect the hex lock to the driveshaft. If you mount your gears or a weightlifting spool (p. 9) on the back of the nacelle, the hex lock will not slip on the driveshaft.
2. The Hub Quick Connect (HQC) allows for easy removal and attachment of the hub. This enables users in busy classroom environments to change blade configurations quickly and easily.

Strong wind, large or out of balance turbine blades and worn out can make the HQC unstable.

There are a couple easy solutions if your hub is falling off the HQC. Adjust your blades to make sure their weight, pitch, size, and shape are all equal so that your rotor is well balanced. Pushed the hub in as far as you can. Glue the hub into the HQC. The HQC also has a small hole in which you can insert a screw to hold the hub in place.

Hold the HQC with one hand, while pulling off the KidWind Hub.

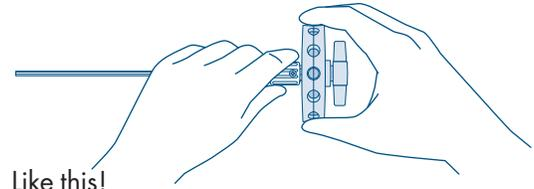

Like this!

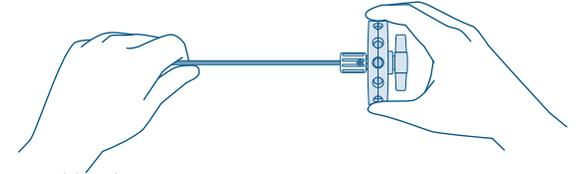

Not like this!

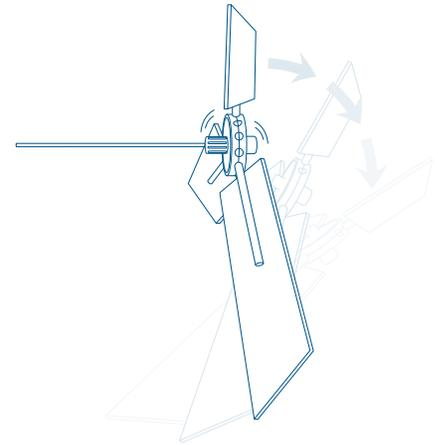

The hub is designed to have a very tight fit to the Quick Connect, but if your blades are unbalanced or your turbine is not directly facing the wind, it may come loose. Be careful with blades that are out of balance.

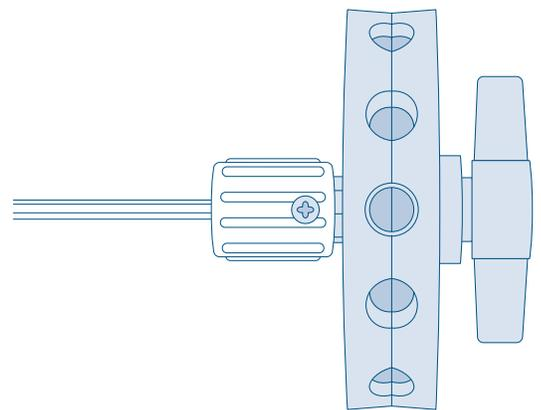

You can use a small screw as a set screw, if you need the hub to be more firmly fixed to the driveshaft.

Notes

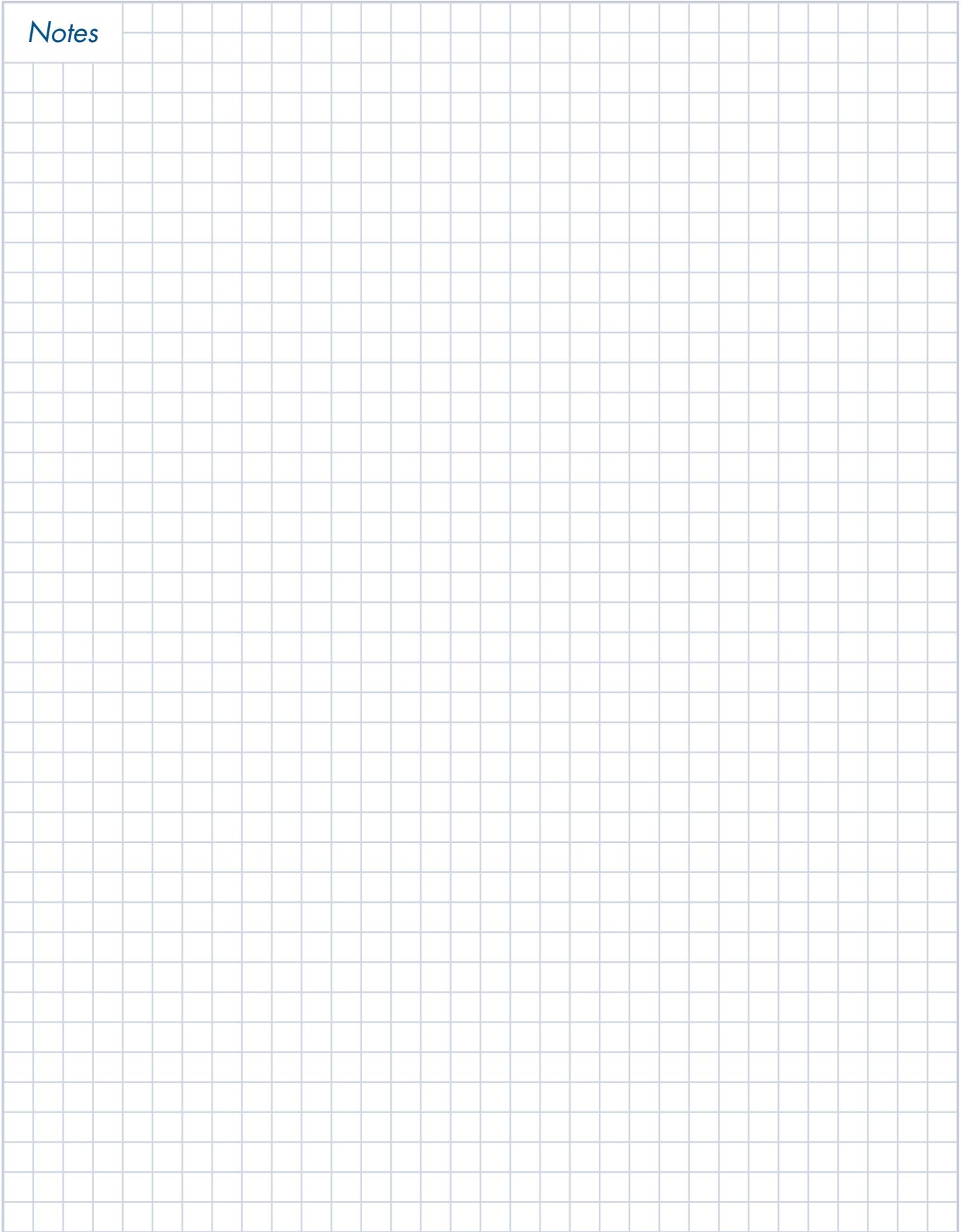

Notes

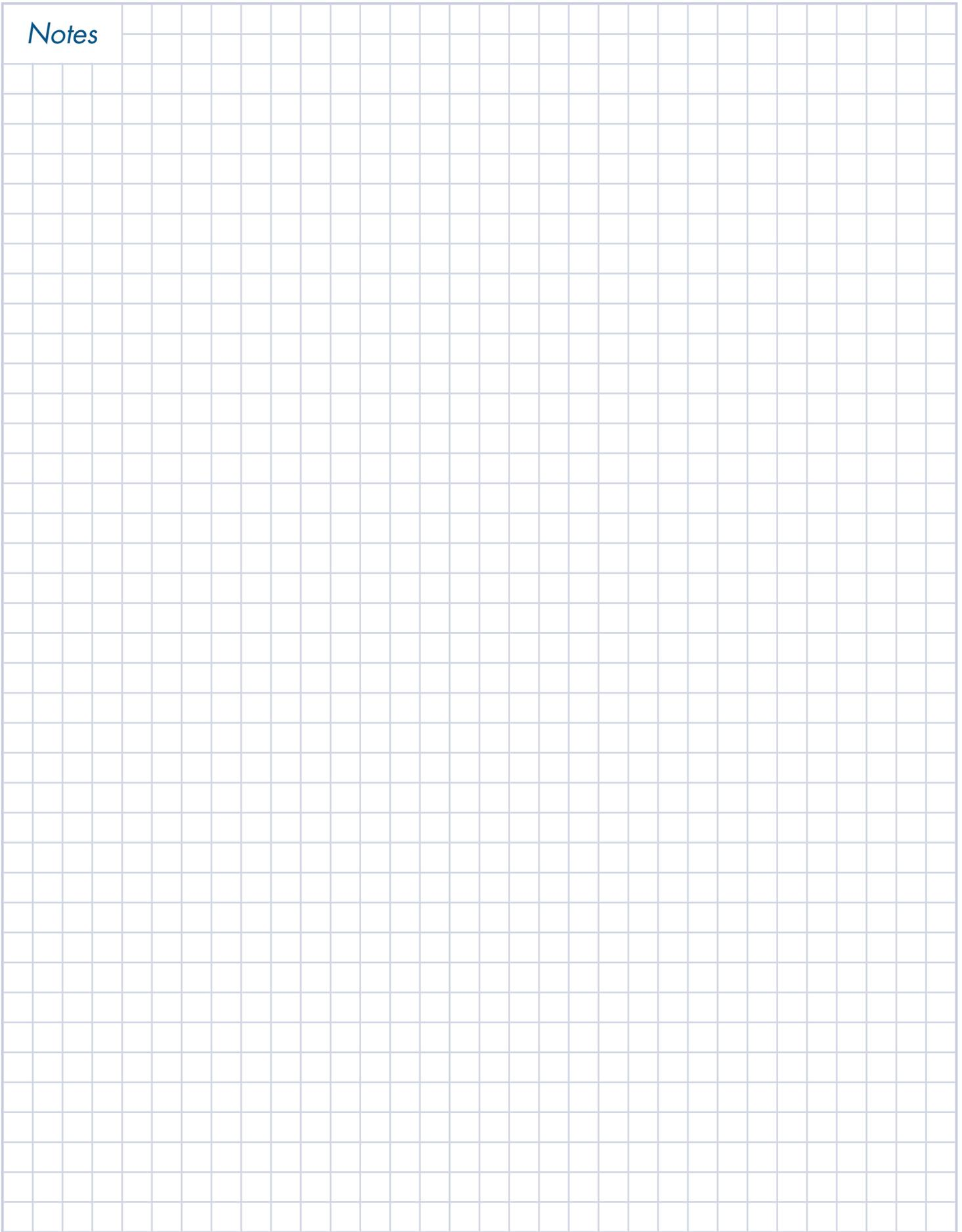



800 Transfer Road, St. Paul, MN 55114
www.KidWind.org ♦ Phone: 877.917.0079
Fax: 208.485.9419

© Copyright 2013 All rights reserved