

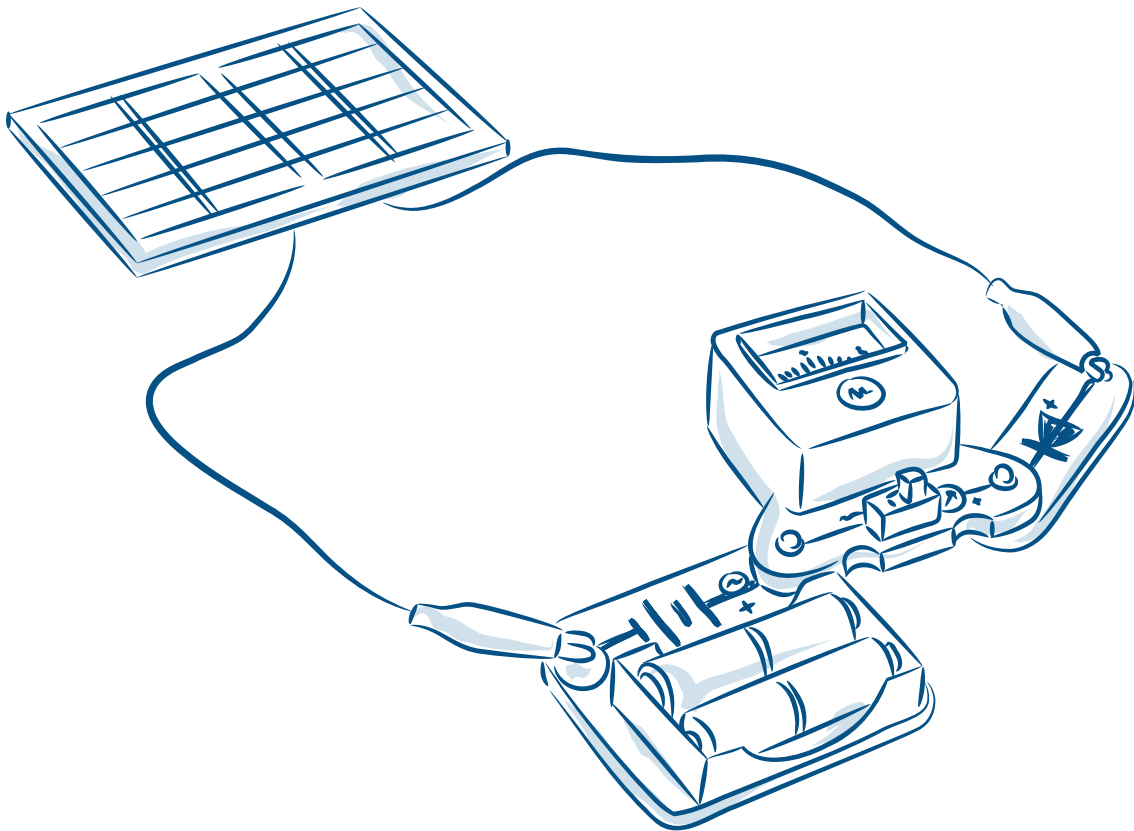

Battery Charging Experiment Kit



About KidWind

The KidWind Project is a team of teachers, students, engineers, and practitioners exploring the science behind wind and other renewable forms of energy. Our goal is to make renewable energy widely accessible through hands-on activities which are challenging, engaging and teach basic science and engineering principles.

Thanks to ...

We would like to thank the Wright Center for Science Education at Tufts University for giving us the time and space to develop this idea into a useful project for thousands of teachers.

We would also like to thank Trudy Forsyth at the National Wind Technology Center and Richard Michaud at the Boston Office of the Department of Energy for having the vision and foresight to help establish the KidWind Project in 2004. Lastly, we would like to thank all the teachers for their keen insight and feedback on making our kits and materials first rate!

Wind for All

At KidWind, we strongly believe that K–12 education is an important foundation for promoting a more robust understanding of the opportunities and challenges that emerging clean energy technologies present.

The Wind for All program seeks to support teachers and students all over the globe who do not have the financial capacity to access our training programs and equipment. We believe that all teachers and students—regardless of where they live or what school they attend—must be part of the clean energy future.

A Note on Reproduction

This work may not be reproduced by mechanical or electronic means without written permission from KidWind, except for educational uses by teachers in a classroom situation or a teacher training workshop. For permission to copy portions or all of this material for other purposes, such as for inclusion in other documents, please contact Michael Arquin at KidWind: michael@KidWind.org

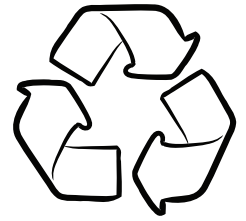

Our plastic components are made from recycled resins.



Made in US

We source domestically whenever possible, and assemble and pack our kits in St. Paul, MN.



Proceeds from your purchase help us train and supply teachers.

Battery Charging Kit

Parts

- 1 6V solar panel
- 2 AAA NiMH rechargeable batteries
- 1 Digital multimeter
- 2 Alligator clip cords
- 1 Sound & Light Panel
- 1 3 ohm, 10 watt resistor
- 1 Supercapacitor
- 2 Battery size adaptors (AAA to AA)
- 1 Snap circuits battery holder (holds two AA batteries)
- 1 Snap Circuits two-spring socket
- 1 Snap Circuits analog ammeter
- 1 Snap Circuits diode
- 2 Snap Circuits jumper wires (red and black)

Recommended materials (not included):
Stopwatch

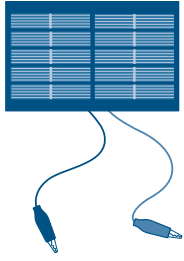

Solar panel (1)

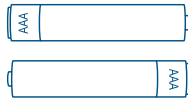

Batteries (2)

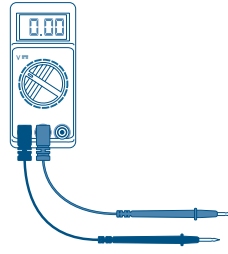

Multimeter (1)

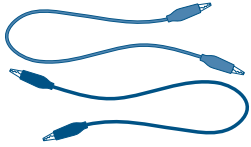

Alligator clip cords (2)

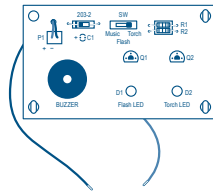

Sound and Light Board (1)



Resistor (1)

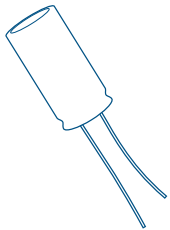

Supercapacitor (1)

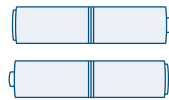

Battery adaptors (2)

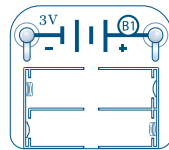

Battery holder (1)



Two-spring socket (1)

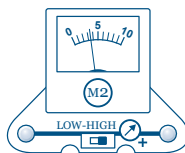

Analog ammeter (1)

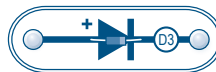

Diode (1)

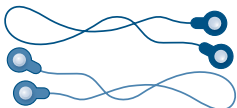

Jumper wires (2)

READ CAREFULLY

To avoid damaging your batteries or harming yourself, read these instructions thoroughly before you begin charging.

PHOTOVOLTAIC (PV) PANELS

Solar Electric panels are also called Photovoltaic (or PV) panels. A PV Panel is a device that converts solar radiation (sunlight) into direct current electricity. This electricity can be used to power electric appliances or charge batteries.

⚠️ USE ONLY NIMH BATTERIES!

Only use NiMH (Nickel Metal Hydride) rechargeable batteries! Do not use any other type of rechargeable batteries. Do not use conventional batteries.

DRAIN YOUR BATTERIES

In the discharge circuit, the big resistor (3 ohm resistance, 10 watt capacity) is what drains the batteries (you may feel this resistor get warm as the batteries discharge). The Sound & Light Panel is the indicator of when the batteries are discharged. On the Sound & Light Panel, you can select: LED, Flashing LED, or Sound Chip.

Circuit for discharging your batteries

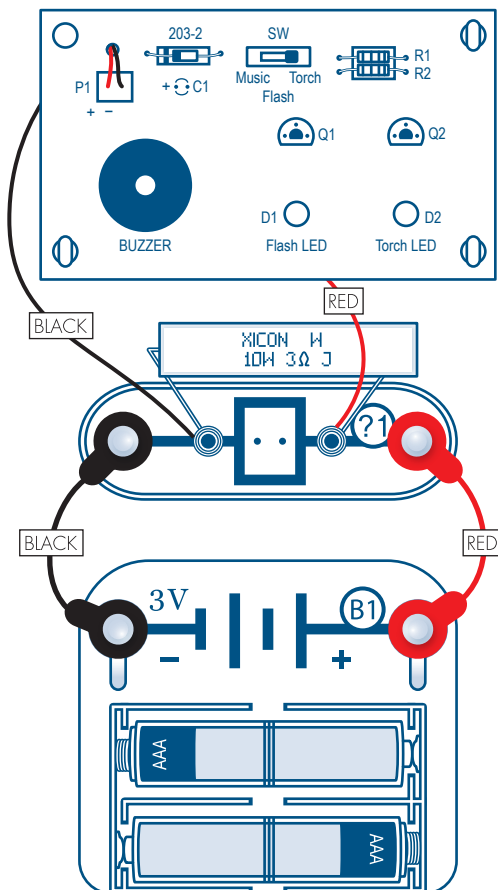

One of the frequently mentioned drawbacks of renewable energy technologies is that they cannot supply electricity consistently. Energy from the wind and sunlight are variable resources: we can only get wind power when the wind blows! That is why many scientists and engineers are interested in battery technology. By charging batteries, we can ensure that we have electricity when we need it—even if the wind is not blowing our turbine or the sun is not shining on our PV panels!

Using several batteries connected into “battery banks,” some homeowners have succeeded in taking their homes “off grid.” This means they are no longer connected to the electric transmission grid—all the wires we see criss-crossing overhead. These homes provide electricity using wind turbines, solar panels, and/or diesel generators. They store excess energy in battery banks to ensure that they have enough electricity to get them through a few days without wind or sun.

This kit explores battery charging with solar panels. It is also possible to charge batteries with some KidWind turbines—like the ALTurbine or Geared Turbine. While you can certainly buy other solar chargers for small batteries, iPods, cell phones, etc, this kit lets you explore the science behind battery charging and build the circuit yourself!

The same instructions will also apply for size AA batteries if you wish to charge your own AA NiMH batteries. Remember that it will take much longer to charge and discharge AA batteries than the AAA batteries included in this kit.

To avoid damaging your batteries or harming yourself, read these instructions thoroughly before you begin charging.

Charge time vs. discharge time

Assemble the batteries

1. Place each AAA battery into a plastic battery adapter. This adapter makes the AAA battery fit into the AA battery holder. AAA batteries work better for this experiment, but you can also use AA batteries.
2. Insert both batteries into the battery holder.

Initial discharge

The batteries we send in this kit come mostly charged. To begin the experiments, you need to discharge your batteries to a standard baseline.

Assemble discharge circuit

1. Connect the large resistor to the two-spring socket (one lead gets pinched in each spring).
2. Connect the wires from the Sound & Light Panel to the two-spring socket (one lead gets pinched in each spring. The spring with the red wire is the positive side of the socket).

3. Attach the snap-cords to the two-spring socket. The red snap-cord goes on the same side as the red wire from the Sound & Light Panel.
4. Connect Battery Holder to discharge circuit, by connecting the red snap-clip to the positive terminal of the battery holder, and the black snap-clip to the negative terminal of the battery holder.
5. Watch the Sound & Light Panel as the battery drains. When the LED is totally out or the sound chip is quiet, this indicates the batteries are at the standard baseline point of discharge. This should take 10–15 minutes with AAA batteries.
6. Disconnect the batteries from the discharge circuit as soon as the LED is out or the sound chip is quiet. Your batteries are not fully discharged, but are now at a known "baseline" charge level where you can begin your experiment.

Charging with a solar panel

Assemble the charging circuit

1. Connect the positive (red) lead from the solar panel to the positive (+) terminal of the diode.
2. Connect the negative terminal of the diode to the positive (+) terminal of the M2 Meter.
3. Connect the negative terminal of the M2 Meter to the positive (+) terminal of the battery holder.
4. Connect the negative (black) lead from the solar panel to the negative (-) terminal of the battery holder.
5. Place this circuit in full outdoor sun.
6. Let the solar panel charge the batteries for 10 minutes.
7. Disconnect the charging circuit

Measure discharge time

1. Connect the battery pack to the discharge circuit.
2. Time how long it takes for the LED to go fully out. Record this time in your data sheet.

Repeat experiment with longer charge time

1. Repeat the experiment, but this time leave the charge circuit in full outdoor sun for 20 minutes.
2. Connect the battery pack to the discharge circuit. Measure how long it takes for the LED to go out. Record this time in your data sheet.
3. Repeat the experiment, this time charging for 30 minutes.

MEASURING CURRENT

There should be a reading on the M2 current meter, to indicate that current is flowing from the solar panel into the batteries, and charging the batteries. (When the meter is set to "High", then full scale is one amp, the "10" on the meter is 1.0 amp (1000 mA).

WHAT IS A DIODE?

The diode is like a one-way valve. It allows current to flow from the solar panel into the batteries but prevents current from the batteries to flow back into the solar panel.

Circuit for recharging your batteries

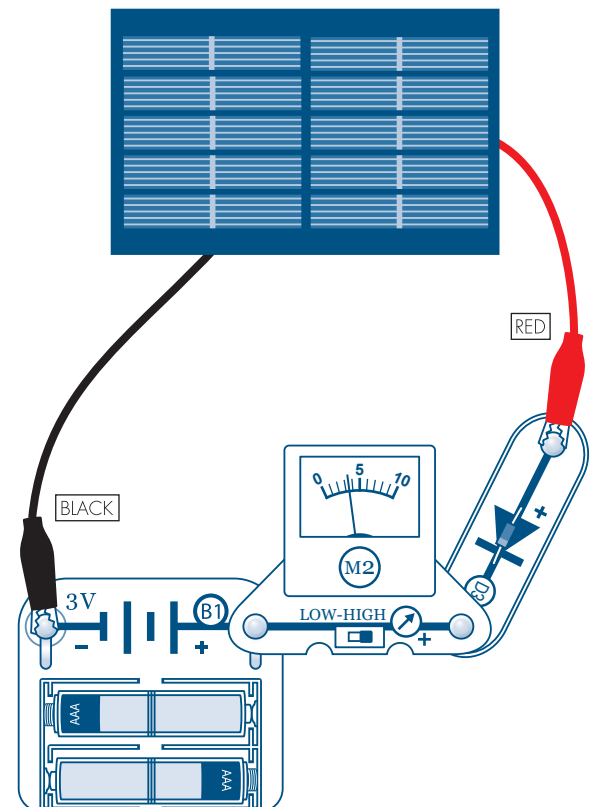

POLARITY (+ OR -)

On a solar panel, the red wire is always positive, and the black wire is always negative. But with a wind turbine, the polarity depends on which direction the blades are rotating. So you need to determine polarity: With the wind turbine spinning in the wind (in front of the fan), connect the volt meter to the leads from the wind turbine. Connect the red lead to red prong. Connect the black lead to the black prong. If the meter reads a positive number, then red is positive and black is negative. If the meter reads a negative number, then the turbine's red lead is negative and the black lead is positive.

WHY SOME KIDWIND TURBINES WILL NOT CHARGE BATTERIES

Direct drive turbines like the KidWind MINI and Basic PLUS do not produce enough amperage to effectively charge batteries. The use of a gearbox increases the RPM of the generator greatly, producing much more power than a direct drive system. With well designed blades the ALTurbine and Geared Turbine produce enough power for battery charging.

Recharging your batteries with a wind turbine

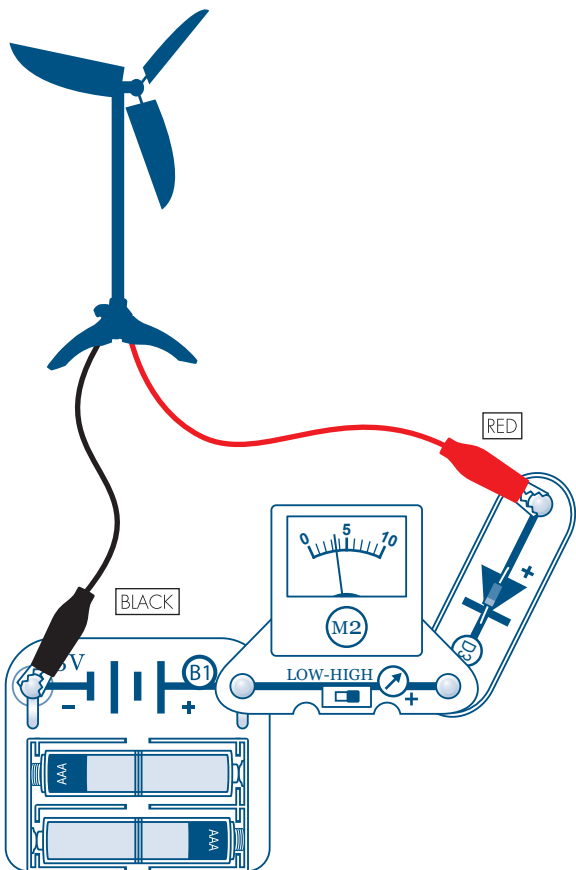

Extension Activities

Fully charging the batteries

Note: this will take almost a whole day. And the batteries need to be monitored frequently.

1. Set up the solar panel in the charging circuit as above.
2. Charge the batteries.
3. Every 30 minutes, disconnect the batteries from the charging circuit and measure their no-load voltage using the digital multimeter.

A single NiMH battery is considered fully recharged when its no-load voltage is about 1.4 volts to 1.5 volts. So the combined voltage of the battery pack would be about 2.8 volts to 3.0 volts, when fully charged. Do not continue charging after the batteries reach this level or you will damage the batteries.

Charging batteries with a KidWind wind turbine

Some model wind turbines will work to charge the batteries and some will not work. The KidWind ALTurbine or Geared Turbine will create enough power to charge batteries, but the Basic and MINI turbines do not produce enough juice.

1. Start with batteries that have gone through the discharge circuit.
2. Connect your wind turbine to the charging circuit. Connect the wind turbine in place of the solar panel.
3. Now connect your wind turbine to the charging circuit. Let the turbine spin in the wind (a box fan is recommended). If the ammeter shows a current flow, the turbine is charging the batteries.
4. Let the wind turbine charge the batteries for 10 minutes.
5. Turn off the wind and disconnect the batteries from the circuit.
6. Connect the battery pack to the discharge circuit and measure discharge time. Record this time in your data sheet.

Charging supercapacitors

Supercapacitors are polarized, which means that they have positive and negative terminals. Because of this, you have to properly connect your electricity source (wind turbine, solar cell, etc.) to the supercapacitor. Sometimes terminals are marked with (+) and (-) signs, but you always know that the longer lead on the supercapacitor is the positive terminal.

Your solar panel also has (+) and (-) leads. The red wire is positive (+) and the black wire is negative (-). If you are using a wind turbine, this can get more complicated since the polarity will change depending on which direction the blades are rotating.

The positive lead from your wind turbine, solar cell, or battery should attach to the long (+) lead on the supercapacitor. The negative lead goes to the short (–) lead on the supercapacitor.

If you are sure you have the correct polarity, you can start to pump some energy into the supercapacitor! Turn the fan on to start your turbine or shine some light on your solar panel. Then wait a few minutes. Now you can use this stored energy to power small electrical gadgets!

Other ideas

1. Repeat the experiment on a cloudy day. Record cloud conditions in your data sheet. Compare data for different cloud conditions.
2. Experiment with solar panel angle. Perform 3 trials of the 10 minute charge, changing the solar panel angle for each trial. Angle the panel at 60°, 30°, and flat on the ground (0°). When you are angling the panel, point it towards the sun.
3. Charging efficiency at different times during the day: repeat the experiment at different points through the day. 9:00 AM, 12:00 PM, 3:00 PM, 6:00 PM. Which time of day was best for charging the batteries?

Advanced Calculations

Calculate milliamp-hours charged and discharged

The ammeter is used in the charging circuit so you can measure how much current—in milliamps (mA)—are going to the batteries. Remember that the total capacity of your battery is measured in mAh (milliamp-hours). You can calculate how many mAh you have theoretically pushed into your batteries by multiplying the charging rate (mA) times the hours (or fraction of hours). For example, if you charge batteries for 10 minutes at a rate of 150 mA:

$$\frac{10 \text{ minutes}}{60 \text{ minutes per hour}} \times 150 = 25 \text{ mAh}$$

Now—when you discharge the batteries, place the ammeter in the discharge circuit as well. Now you can measure mA going out of the battery and multiply this rate times the hours (or fraction of hours) to calculate mAh discharged from the battery.

By comparing how much went into the batteries, compared to how much came out of the batteries, you can compute the efficiency of the charging process.

Charging: _____ mA × _____ hour = _____ mA Hours

Discharging: _____ mA × _____ hour = _____ mA Hours

Using the ammeter to calculate the milliamp-hours discharged.

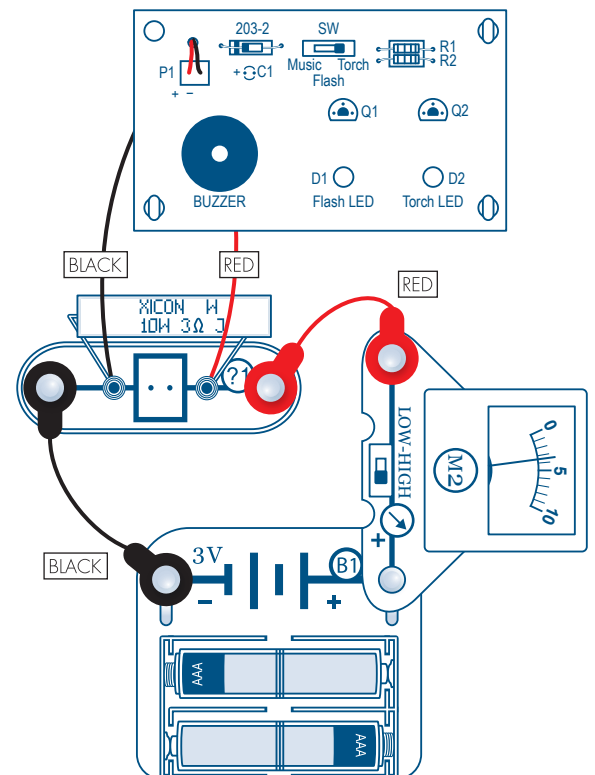

Using the ammeter *and* multimeter to calculate the watt-hours discharged.

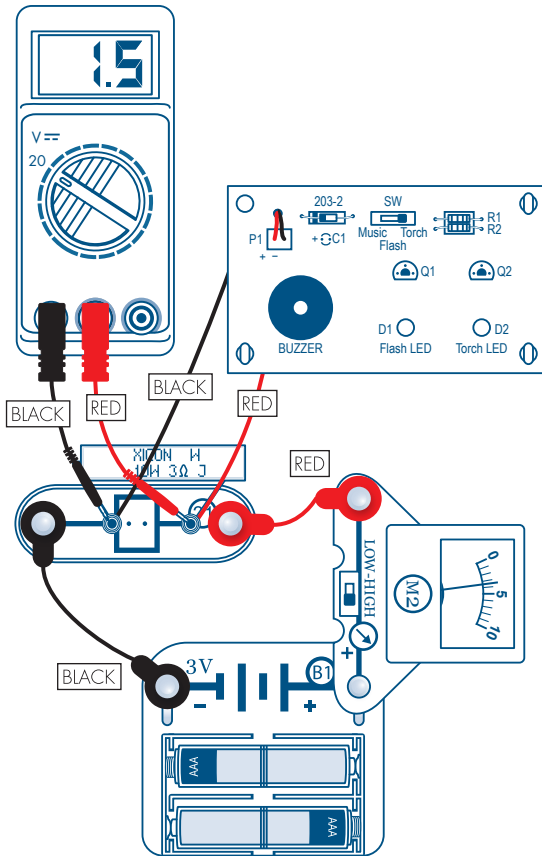

Calculate watt-hours charged and discharged

Calculating the mAh charged into and discharged out of our batteries tells us a lot, but if we really want to know how much energy is going in and out it is better to calculate watt-hours.

You may be familiar with the watt as a unit of power. For example, a 60 watt bulb draws 60 watts of power to emit light. Watt-hours, on the other hand, are a unit of energy. For example, if that same 60 watt bulb was left on for 2 hours, it would have used 120 watt-hours of energy.

To calculate watt-hours, you will have to measure both the milliamps and the voltage as you charge and discharge the batteries. Power (watts) = volts x amps. Energy (watt-hours) = watts x hours. Remember to convert milliamps into amperes and minutes into hours! Here is an example:

Your solar panel is charging batteries at a rate of 150 mA and 2.5 volts for 10 minutes. How many watt-hours went into the batteries?

$$\frac{150 \text{ mA}}{1000 \text{ mA per ampere}} \times 2.5 \text{ volts} = 0.375 \text{ watts}$$

$$\frac{10 \text{ minutes}}{60 \text{ minutes per hour}} \times 0.375 \text{ watts} = 0.0625 \text{ watt-hours}$$

Electricity Basics

There are three fundamental electrical properties: voltage, current, and resistance.

Voltage (V), also called potential difference, is the amount of potential energy available to cause a given number of electrons to flow through a circuit. The more energy that exists for each available electron to flow, the higher the voltage. If we compare electricity to a waterfall, voltage would represent the height of the waterfall—the higher the waterfall, the more potential energy the water has, and the more energy it will have when it hits the bottom.

Current (I) is measured in amperes or amps (A). Current is an indicator of how many electrons are flowing through a point in a circuit in a given amount of time (how much electricity is flowing). In the waterfall example, the current would represent how many gallons of water are going over the edge of the falls each second. For the purpose of small battery charging, it is more useful to talk about current in terms of milliamps (mA) which is equal to 1/1000 of an ampere.

Resistance, measured in ohms (Ω), refers to how much the material that is conducting electricity (wires, light-bulb, resistor, etc.) opposes the flow of electrons. For a given amount of voltage being applied to a circuit, a

Using the ammeter *and* multimeter to calculate the watt-hours during charging.

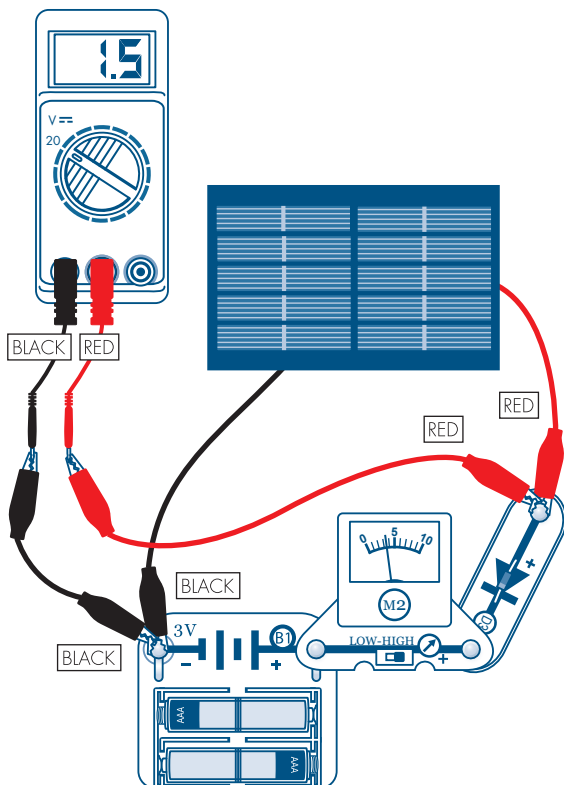

higher resistance in it means less electric current is able to flow through that circuit. The lower the resistance, the more current will be able to flow.

In a waterfall, large rocks or a dam above the falls would oppose the flow of water, similarly to how resistance opposes the flow of electrons.

Watts: The unit of power is the watt. $\text{watts} = \text{volts} \times \text{amps}$. The higher electrical potential times a high flow of electrons equals a high wattage. With a waterfall, the height times the volume of water would be the equivalent of watts.

Watt-hour: Unit of energy. $\text{Watts} \times \text{hours} = \text{watt-hours}$. For small quantities, mW (milli-watts) are used, the unit of energy is mWh.

Ohm's law: $V = I \times R$ (voltage = current \times resistance)

It will be important to understand these properties when charging batteries. Most AA and AAA rechargeable batteries have a "nominal" voltage of 1.2 volts; when they are fully charged they will have a no-load voltage (not connected to anything) of about 1.4 V to 1.5 V. So a pair of the included AAA batteries will measure about 2.8 V to 3.0 V (no load) when fully charged. This is one way to measure when the batteries are fully charged.

Batteries

What is a battery?

An electrical battery is a device that can convert chemical energy into electrical energy. Batteries come in many shapes and sizes, and may be composed of a myriad of different chemicals, but all batteries can be classified under two categories: primary batteries and secondary batteries.

Primary batteries are meant to be used once and then discarded. These disposable batteries are commonly used in small electronic devices. Alkaline batteries are the most common primary battery type, but there are several other types as well.

Secondary batteries are designed to be recharged and used again and again. The Nickel-Metal Hydride (NiMH) batteries included in this kit are a very common type of secondary battery. The lead-acid batteries found in cars are also considered secondary batteries.

How much energy can a battery store?

Energy is a unit that combines power and time such as kilowatt-hours or watt-seconds. The quantity of energy stored in a battery is equal to the amount of power the energy provides, multiplied by the time this power flows. Batteries are typically rated in milliampere-hours (mAh). The included AAA batteries are rated at 1,000 mAh. Remember that power is equal to voltage multiplied by amperage. This storage rating only tells

Water analogy for voltage, current & resistance.

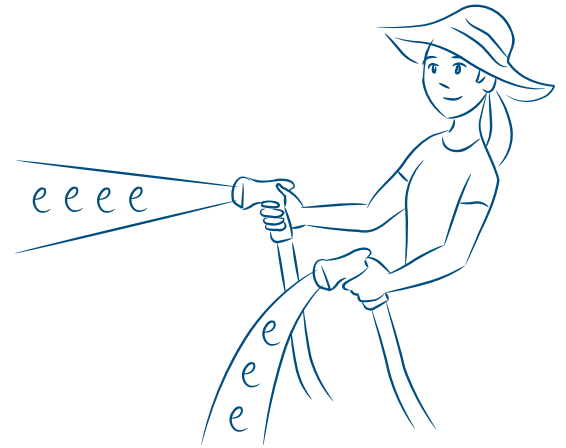

High voltage = high pressure
Low voltage = low pressure

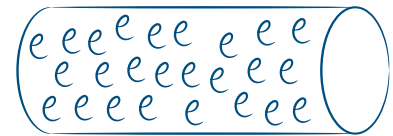

More Current = more electron flow

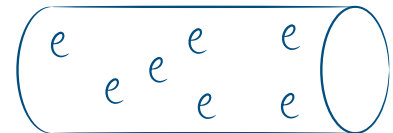

Less Current = less electron flow

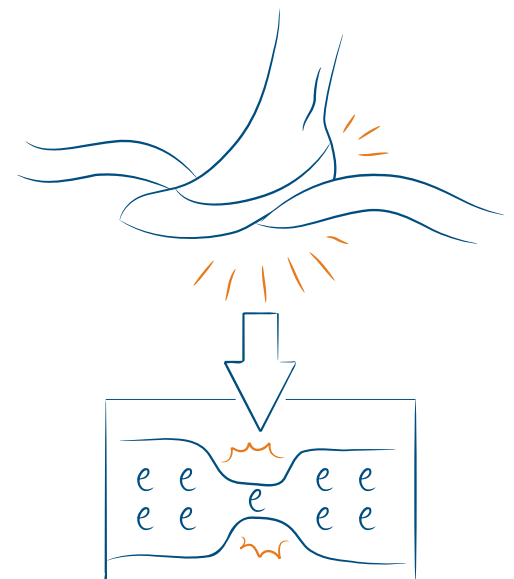

Higher resistance needs more voltage to push electrons through

us amperage and time—but since we know the average voltage of the battery during discharge (1.2 volts for AAA NiMH batteries), we can calculate watt-hours:

$$\frac{1,000 \text{ mAh}}{1,000 \text{ mA per A}} \times 1.2 \text{ volts} = 1.2 \text{ watt-hours of energy per battery}$$

Battery capacity

Battery capacity is usually rated in mAh. (milliampere-hours). Milliampere times Hours equals mAh.

The included AAA batteries are rated at 1,000 mAh each. This could mean 1,000 mA for one hour, 1 mA for 1000 hours, 50 mA for 20 hours, etc. Note that the batteries will only deliver their fully rated 1,000 mAh if discharged slowly.

Two of these batteries will have a rated capacity of 1,000 mAh. (Since they are connected in series, their voltage is additive but current is not).

Practical applications—batteries and renewable energy

Batteries are an important technology to combine with renewable energy. Because renewable sources of electricity are variable and inconsistent, having electricity stored in batteries helps ensure that electricity can be provided when it is needed!

Going off-grid

Some homeowners are getting sick of paying monthly electric bills and have opted to go off-grid! This means that they are generating their own electricity without the help from the electric utility company. An off-grid house may use any combination of small wind, solar, micro-hydro, and/or diesel generators—but almost all off-grid homes use batteries to store electricity.

Large scale wind-to-battery projects

Some companies are investing in *huge* battery banks to store large amounts of electricity from utility-scale wind farms. For example, the Xcel Energy Wind-to-Battery project installed a 1 megawatt capacity battery at an 11 megawatt wind farm in Minnesota. After two years of testing, the battery system has been hugely successful. The batteries help shift wind energy from when the wind blows to when there is large demand for electricity and help compensate for the variability of wind generation. These gigantic batteries are roughly the size of two semi trailers!

Plug-in-electric cars

You may have heard about plug-in-electric cars like the Nissan Leaf or the Chevrolet Volt. Automobile manufacturers are feeling the pressure to move away from traditional internal combustion engine vehicles which burn fossil fuels and contribute to global warming. Electric cars use huge batteries and electric motors for propulsion. These batteries can be recharged



New electric cars have zero-emissions at the tailpipe. They are only truly zero-emission, however, if the electricity used to charge their batteries comes from zero-emission sources.

using renewable energy like wind and solar. Even when charged using the current electric mix in the US, using an all-electric car would reduce carbon dioxide emissions by 30%. One of the major drawbacks of an all-electric vehicle is the range the vehicle can travel on batteries alone—so manufacturers are constantly researching how to store more energy in the smallest, lightest, and least costly package.

Supercapacitors

A capacitor is similar to a battery because it can store and release electrical energy; but capacitors work very differently from batteries.

Batteries are charged by chemical reactions. Every battery has two terminals. The chemical reactions inside the battery produce electrons on one terminal and absorb electrons on the other terminal. The chemical reaction is reversed to deliver the energy of a battery.

A capacitor does not use chemical reactions at all. Instead, two metal plates separate negative charges from positive charges, creating voltage.

Supercapacitors (also called "ultracapacitors") are different from normal capacitors because they are able to hold a much greater charge. Their potential is greater, and the total energy stored can be much higher.

Chemical reactions can take some time, but releasing the energy stored in capacitors can be done very fast. For this reason, capacitors are able to release an enormous amount of power very quickly. However, batteries release steady voltage for a longer period of time, while most small supercapacitors store only enough energy for a few minutes of voltage.

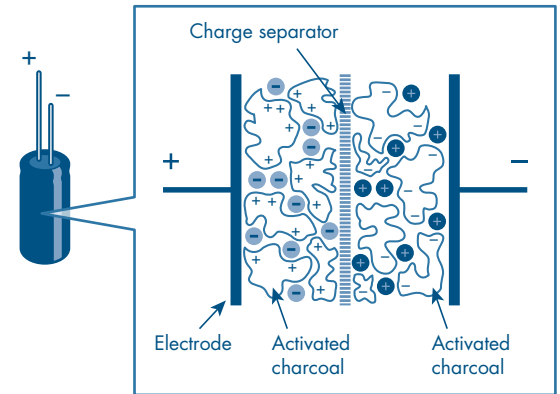

Supercapacitors—or "electric double-layer capacitors"—work by separating charges and storing them in parallel layers of charcoal (carbon). Even in very thin sheets, the activated charcoal has a large surface area, so it can store lots of charge carriers in a compact space. Manufacturers roll these sheets up into tightly-packed cylinders, creating high-density supercapacitors.



800 Transfer Rd. Suite 30B, St. Paul, MN 55114
www.kidwind.org ♦ Phone: 877.917.0079
Fax: 208.485.9419

© Copyright 2013 All rights reserved