

KidWind Geared Wind Turbine

Copyright ©2011



Kidwind Project
800 Transfer Road
Suite 30B
St. Paul, MN 55114
www.kidwind.org

This work may not be reproduced by mechanical or electronic means without written permission from KidWind, except for educational uses by teachers in a classroom situation or a teacher training workshop. For permission to copy portions or all of this material for other purposes, such as for inclusion in other documents please contact Michael Arquin at the KidWind Project at michael@kidwind.org.



The production of the kits and other materials related to wind energy have been generously supported by these agencies.



We would like to thank the *Wright Center for Science Education* at Tufts University for giving us the time and space to develop a nugget of an idea into a useful project for hundreds of teachers.

We would also like to thank Trudy Forsyth at *National Wind Technology Center* and Richard Michaud at the *Boston Office of the Department of Energy* for having the vision and foresight to help keep the KidWind Project going! Lastly we would like to thank all the teachers for their keen insights and feedback on making these wind turbine kits and materials first rate!

Geared PVC Wind Turbine Parts List (FULL KIT)

Tower

- ◇ (1) 20" Wood Tower
- ◇ (3) Tower Base Set (3 Legs, 1 Base, 1 Locking Disc)

Turbine Parts

- ◇ (1) 12 Hole Crimping Hub
- ◇ (1) Geared Head with Hub Quick-Connect

Power Output Devices

- ◇ (2) Alligator Clips
- ◇ (1) Simple Multimeter
- ◇ (2) LED Bulbs
- ◇ (2) Incandescent Bulbs
- ◇ (1) DC Motor
- ◇ (1) Black Propeller
- ◇ (1) Pump and Cylinder System
- ◇ (1) Power Output Board
- ◇ (1) Set of Resistors

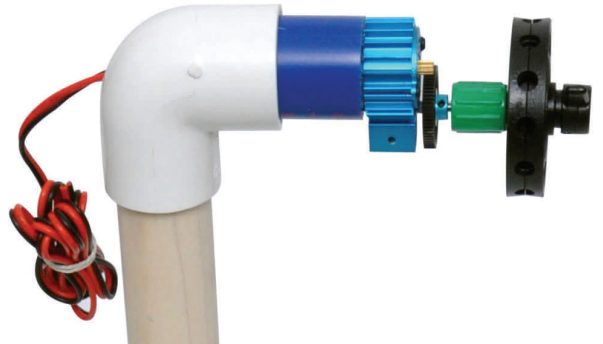

Blade Materials

- ◇ (25) 1/4" diameter poplar dowels
- ◇ (5) 18" sheets of balsa wood
- ◇ (5) 16" Corrugated Plastic Sheets
- ◇ (1) KidWind Protractor

Tools

To build this turbine, you'll need at minimum wire strippers, tape, and glue.

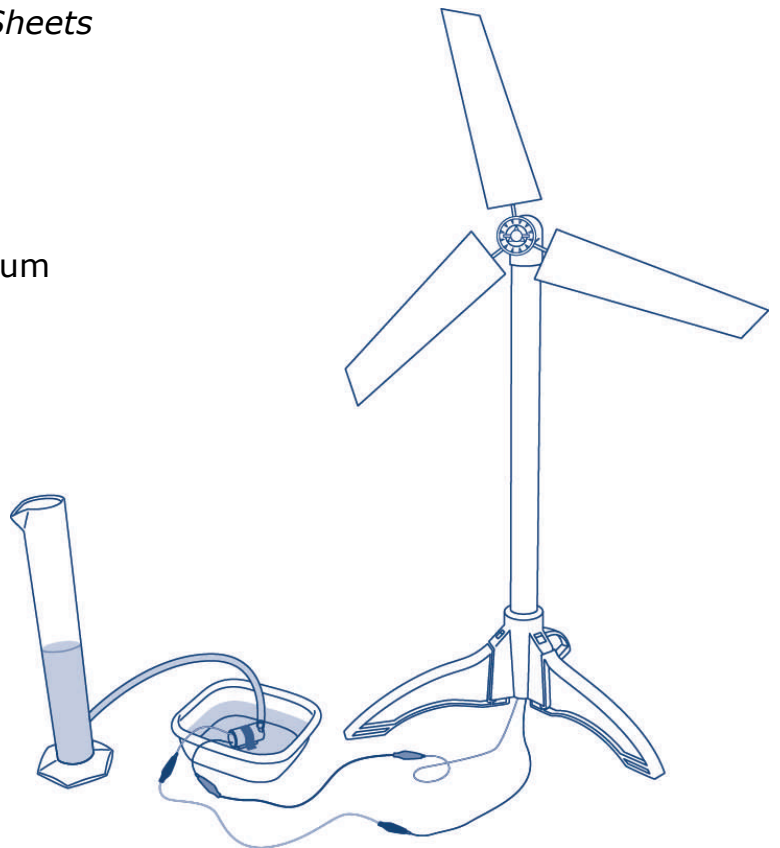

Geared PVC Wind Turbine



These instructions will show you how to build the *Geared PVC Wind Turbine*. While the geared head comes pre-assembled, you will have to put a few parts together to finish the job. This turbine couples a rugged, variable design with substantially higher power output.

The Geared Drive Shaft

The gearbox is the reason this turbine creates much more power than our other PVC turbines. The gear ratio on this device is about 7:1, so for every 1 rotation of the hub, the shaft turns 7 times. While the gearbox is fairly robust, it needs to be treated with some care.

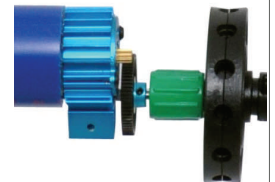

DO NOT:

- Strike or bend the driveshaft—this will render your wind turbine non-functional.
- Get dirt or grit in the gear area. This will cause poor operating efficiency.
- Don't push hard on the hub when inserting blades as this can bend the driveshaft (see earlier caution).

The Geared PVC Wind Turbine can power a wide variety of accessories. Some of these include:

- Fuel Cells
- LEDs
- Incandescent Bulbs
- Mini Water Pumps
- Small Motors
- Ultra Capacitors
- Any other small applications that you can think of

Building the Tower & Base

Wood Tower

1. Lock one leg onto the center hub.
2. Attach the two other legs in the same way.
3. Slide the locking disc on to the tower about 6 inches.
4. With the teeth of the locking disc pointing down, insert the tower into the center hub.
5. Slide the locking disc down the tower and into the hub, locking the tower in place

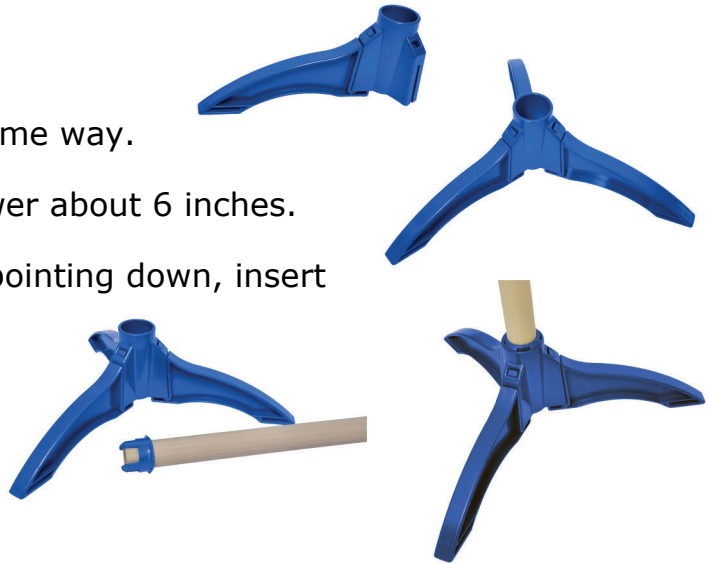

Note: *If your blades are not properly balanced or you experience a particularly strong wind, this tower may shift, wobble, or even fall down! To avoid a catastrophic tower failure, we recommend securing your tower to the floor or a table using a little bit of tape.*

You can also build a **PVC tower** for your turbine:

Parts Needed: (All 1" diameter)

- ◆ (4) 90° PVC fittings
 - ◆ (6) 6" PVC pipe sections
 - ◆ (3) PVC T fittings - Drill a small hole in one "T"
 - ◆ (1) 24" PVC pipe section
1. Using (4) 90° PVC fittings, (2) PVC Ts and (4) 6" PVC pipe sections, construct the two sides of the PVC turbine base. Make sure in this step to use the PVC Ts that **DO NOT** have a hole drilled in them.
 2. Fit the parts together without using glue (PVC glue is really nasty stuff). To make them fit snugly tap them together with a hammer or bang them on the floor once assembled.
 3. Next, connect the two sides of the base using the PVC T with the hole. The hole will allow you to snake out the wires from the DC motor.
 4. Slide the generator head (nacelle) onto the tower. Run the wires down through the post and through the hole in the PVC T at the center of the base. Attach the tower to the base.
 5. Attach alligator clips to the wires. Then straighten all parts and make sure joints are secure.



(2) Identical Base Sides



Sides joined together.

Make sure to use a PVC T with a hole drilled so you can get the wires out!



Building & Attaching Blades



Caution!!

Never make blades out of metal or any sharp edged material because they could cause injury during testing. Blades tend to spin very fast (300-600 RPM) and can easily cut people if they have sharp edges.



1. To make blades, carve or cut different shapes and sizes out of a variety of materials (wood, cardboard, felt, fabric). Tape or hot glue them to the dowels. Students have made blades out of **styrofoam bowls, pie pans, and paper and plastic cups**. Anything you find around the house or classroom can be made into blades!

2. Before testing check that the blades are securely attached to the dowel. If not secured properly, they may detach or deform as you test your turbine in high winds. We recommend using a combination of tape and hot or regular glue.

3. Insert the dowels into holes on the crimping hub. It is important to tighten the hub when inserting the blades so that they do not come out at high speed.

4. When attaching the blades to the hub consider a few important questions:

- How close is the root of your blade to the hub? What do you think is optimal?
- Are your blades about the same size and weight? Blades that are not balanced will cause vibrations that can reduce the efficiency of your turbine..
- Are the blades equally distributed around the hub? If not you can also have a set up that is out of balance.
- Have you secured the hub after you inserted the blades? If not they can fly out at high speed!
- Want to know how fast your blades are spinning? Get a *Hangar 9 Micro Tachometer*.

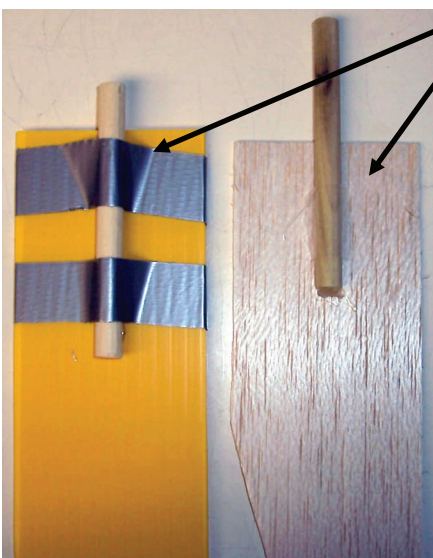

Pie plate used to catch the wind. As the crimping hub can be separated into two parts you can try different creative ways to attach "blades" to the hub. One of the best blades we ever saw was made from a pizza pie box!



Again, **DO NOT USE** sharp metal or very hard plastic to make blades, because blades can spin at very high speeds (500RPM) and could cause injury.



SAFETY & BLADE TESTING AREA



- **It is important to wear safety goggles testing blades.**
- **NEVER make blades out of metal or any sharp edged material as these could cause injury while spinning fast during testing.**

SETUP FOR TESTING

Safely set up your testing area like the picture below. It is important to clear this area of debris and materials.

Make sure the center of the fan matches up with the center of the wind turbine. You may need to raise your fan with some books or a container.

Some things to note about fan wind that reduces the efficiency. Fans create;

- *Highly Turbulent & Rotational Wind*— Blades may spin better one direction than another
- *Highly Variable Wind Speed*— Wind speed is about 10-13 MPH on high for a \$20 circular fan. Wind speeds near the middle will be much different than the edges.
- *Limited Diameter*— Blades bigger than the fan will not “catch” more wind—they will just add drag and slow down your blades.

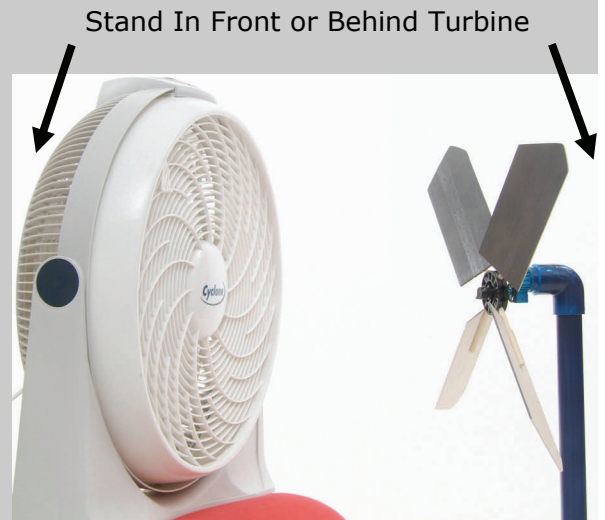

How to Clean Up Wind?

Want some more “professional wind”? You can try to build a simple wind tunnel. Lots of plans can be found online (search term: classroom wind tunnel or go to www.kidwind.org). One simple way to make more laminar—smooth, straightened—flow is to build a honeycomb in front of your fan using milk cartons, 2” PVC pipe or some other material.

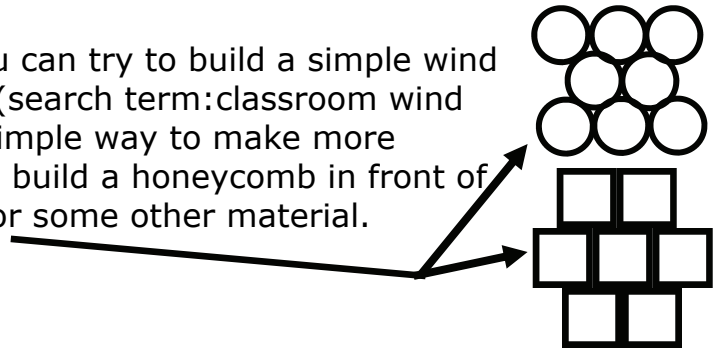

Going Outside?

While you can use your wind turbine outside, you must make sure that you face it into the wind. This is because this turbine is not designed to YAW (or rotate) to face the wind. If the wind shifts, and the turbine cannot rotate, wind will hit the blades from the sides causing stress and inefficiency.

For a wind turbine that can yaw check out the KidWind Yawing Geared PVC turbine on our website (<http://www.kidwind.org>).



Some Blade Building Tips

KidWind model wind turbines are designed for use in science classes, or as a hobby or science fair project. Their purpose is to give students an affordable way to perform various blade design experiments quickly. **Efficient blades are a key part of generating power from a wind turbine. Sloppy or poorly-made blades will never make enough energy to power anything. It takes time and thought to make good blades!**

An important concept to keep in mind when making turbine blades is drag. Ask yourself, **“Are my blades creating too much DRAG?”**. Your blades are probably catching the wind and helping to spin the hub and motor driveshaft, but consider the ways that their shape or design might be slowing the blades down as well. If they are adding **DRAG** to your system it will slow down and in most cases low RPM means less power output.

Some tips on improving blades:

- **SHORTEN THE BLADES** - Wind turbines with longer blades tend to generate more power. While this is also true on our small turbines, it is often difficult for students (and teachers) to make large, long blades that don't add lots of drag and inefficiency. See what happens when you shorten them a few centimeters.
- **CHANGE THE PITCH** - Students commonly set the angle of the blades to around 45° the first time they try to use the turbine. Try making the blades flatter toward the fan (0° - 5°) . Pitch dramatically affects power output, so play with it a bit and see what happens. You can use a protractor to measure the pitch. Finding a way to **TWIST** the blades (0° near the tips and around 10° - 20° near the root) can really improve performance.
- **USE FEWER BLADES** - To reduce drag try using 2, 3 or 4 blades.
- **USE LIGHTER MATERIAL** - To reduce the weight of the blades use less material or lighter material.
- **SMOOTH SURFACES** - Smooth blade surfaces create less drag. Try removing excess tape or smoothing rough edges to reduce drag.
- **FIND MORE WIND** - Make sure you are using a decently sized box or room fan with a diameter of at least 14"-18".
- **BLADES VS. FAN** - Are your blades bigger than your fan? If the tips of your blades are wider than the fan you're using, then they're not catching any wind—they are just adding drag!
- **BLADE SHAPE** - Are the tips of your blades thin and narrow or wide and heavy? The tips travel much faster than the root and can travel faster if they are light and small, meaning if you have wide or heavy tips you may be adding lots of drag.

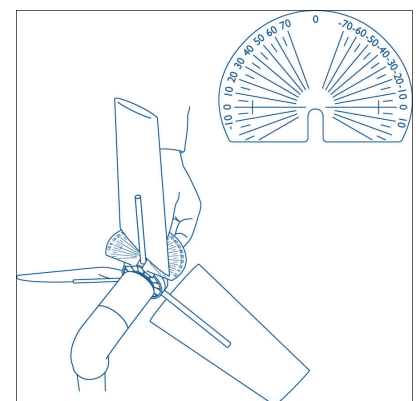
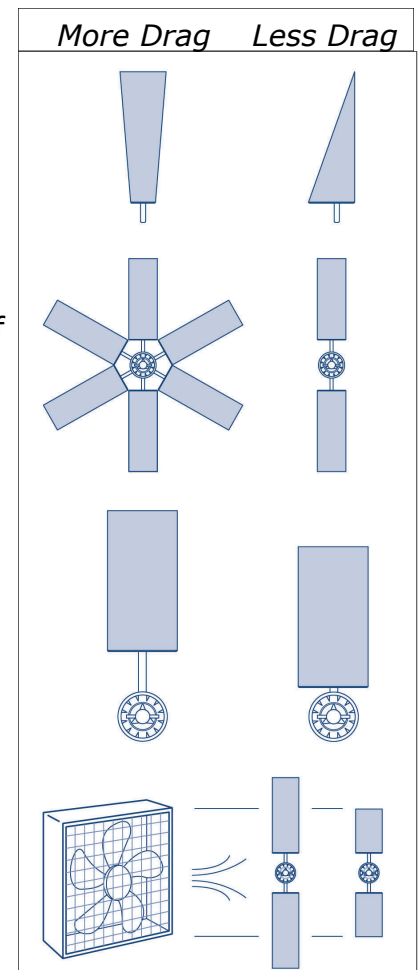

How to use the Multimeter

To accurately measure power production you should use a multimeter. Small DC motors like the one you're using do not produce much power when spun slowly. As a result, the electrical output will be limited and even a great set of blades in high winds might only be able to light an LED. If you are interested in lighting bulbs and creating more electricity you may want to check out the *Geared PVC Turbine* at the KidWind Website (<http://www.kidwind.org>).

Power (Watts) = Voltage (V) x Current (A) <--- Watch Your Units
Make sure you are recording volts and amps (not milli or microvolts unless you want to!)
If your readings are higher than 1– 2 watts you have done something wrong!

Voltage

1. Attach the wires from the generator to the multimeter. Color does not matter!!
2. To check the voltage select DC Volt (V) and set the whole number to 20 volts.
3. Place your turbine out in the wind or in front of a fan and let it run. It is normal for the readings to fluctuate. Power output is often unsteady because the wind is inconstant or your blades are not balanced.
4. A set of very well designed blades may make around 1 –2 volts. Typical blades will be in the 0.5 - 0.8 volt range.
5. When measuring voltage you are calculating how fast the DC generator is spinning. The faster it spins the higher the voltage. Since there is no load on the generator it has very little resistance and can spin very fast. If you look closely when you attach a load (bulb, pump or small motor) the RPM may drop as will your voltage.

Amperage

1. To get a more accurate picture of the power output of your turbine measure amperage as well. To accurately measure the amperage you must hook up your multimeter differently.
2. Place a load (a resistive object - small LED bulb, resistor, pump etc.) in series with the meter so that the generator is "loaded" and has to do work.
3. A set of very well designed blades will produce around 0.1 amps (100 milliamps) with this motor. Typical blades will make .02-.05 amps (20 – 50 milliamps). This will vary based on your resistive load.
4. When measuring amperage you are gauging how many electrons are being pushed through the wire by the turbine. This relates to how much torque your blades are generating.

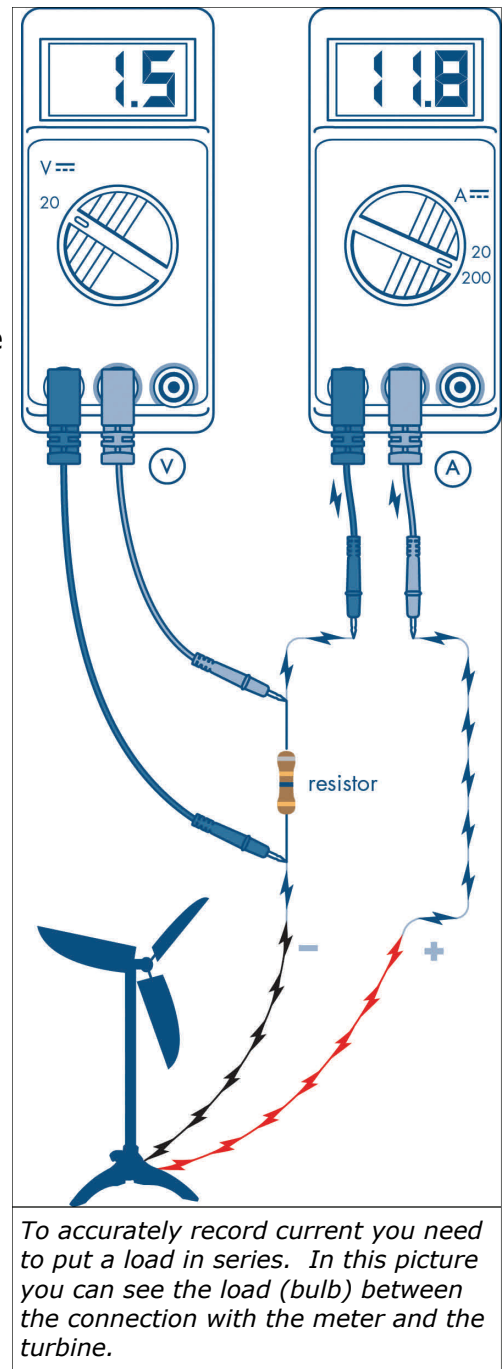

What Can You Do with Your Turbine?

Factors that Affect Power Output

Now that you have a wind turbine, let's start exploring what factors affect the amount of power your turbine produces. Here are a few places to start;

- ***Wind Speed***
- ***Generator Type***
- ***Blades***

Wind speed is an easy variable to change. Take your turbine and place it in front of a fan at three different distances. How does the power output change. Think about this in relation to the *Power in the Wind* equation on page 12. To more accurately measure the wind speed of your fan get a wind meter from Kidwind (www.kidwind.org) or search some ideas on the web to build your own.

Generators

The DC generator in your wind turbine is actually a DC motor that spins using the energy in the wind. The magnets and wires in the generator transform the energy in the wind into electricity. By manipulating the strength of the magnets used and coils of wire inside the generator we can affect the power output. In this kit we provide you with a DC generator preinstalled in the gearbox. If you wanted you could compare this to a different DC generator that you harvest from some old electronics in your house, but you would have to build another gearbox. Old VCRs, electrical toys and CD players are good places to start finding DC motors and gearboxes. Do some research on how generators work or electromagnetism to learn more!



Blade Design

Blade design experiments are an entertaining place to explore how design affects power production. The blades on modern turbines "capture" the wind and use it to rotate the drive shaft of a generator. As we mentioned above the spinning shaft of the generator spins wires near magnets to generate electricity. How well you design and orient your blades can greatly impact how fast these blades spin and how much power your turbine produces.

Experiments with blades can be simple or very complicated, depending on how deeply you want to explore. Some blade variables you can test include:

- *Length*
- *Number*
- *Pitch*
- *Shape*
- *Materials*
- *Weight*

If you are doing this for a science fair or project you should focus on just one of these variables at a time as your results can get confusing quite quickly.

Powering items with your Geared PVC Wind Turbine

The geared turbine puts out more power, so you can put it to use! Try hooking it up to some different loads like the *Kidwind Water Pump*, a Fuel Cell, a buzzer or noisemaker or a short string of Christmas lights.

Light Bulbs & LEDs

You can use the *Geared PVC Wind Turbine* to light small incandescent bulbs or LEDs. LEDs require much less current than incandescent so they are easier for the turbine to light. You can also use other bulbs from flashlights just make sure they are designed for low voltage and low current.

LED lights need at **least 1.75 volts to light**, but very little amperage. LEDs also require that the electricity runs in the **"right" direction**. If your turbine is making more than 2 volts, but the LED is not lighting try reversing the turbine output wires that are connected to the LED bulb and try again.

Small Motors

The power needs of most small DC motors are pretty minimal, especially if they happen to have a low voltage rating. The *Geared PVC Wind Turbine* can easily power a variety of small DC motors. Look for small DC motors in broken electrical toys. You can also find a wide variety of at Kelvin.com, Pitsco or All Electronics online electronics store.

You need around **.6 - .8 volts** to power a small motor with propeller.

Low Voltage Water Pumps.

KidWind uses a low voltage water pump that works well with our *Geared PVC Wind Turbines*. You need to produce around **2.0 volts** for this pump to run well and a good deal of torque as pumping water requires a great deal of energy. This is one of our favorite demonstrations using wind energy. We typically hook it up to some type of graduated cylinder to see whose turbine blades can pump the most amount of water in 1-2 minutes! **Do not try to run 6V or 12V aquarium pumps using our wind turbines it will not work!**

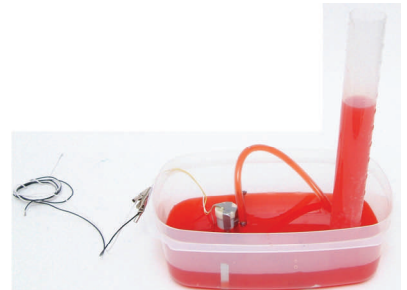

Fuel Cells

We developed the *Geared PVC Wind Turbine* with this application in mind. Using this wind turbine you can generate enough electricity to run a simple fuel cell. When you run electricity through the fuel cell it will create hydrogen and oxygen in a storage chamber which can be recombined to generate electricity. You could use this stored electricity to run the mini-water pump, a small DC motor or you can attach it to a fuel cell car and see how far it travels on two minutes of wind produced electricity-the ultimate in closed loop travel!

To run this device your turbine needs to produce at least **1.75 volts**. **More than 2.0 volts** for sustained periods can also damage your fuel cell so be careful.

Power in the Wind – A Simple Look

If a large truck or a 250lb linebacker was moving toward you at a high rate of speed, you would move out of the way, right?

Why do you move? You move because in your mind you know that this moving object has a great deal of ENERGY as a result of its **mass** and its **motion**. And you do not want to be on the receiving end of that energy.

Just as those large moving objects have energy, so does the wind. Wind is the movement of air from one place on earth to another. That's the motion part.

What is air though? Air is a mixture of gas molecules. It turns out that if you get lots of them (and I mean lots of them) together in a gang and they start moving pretty fast, they can definitely give you — a sailboat or a windmill — a serious push. Just think about hurricanes, tornadoes, or a very windy day!

Why aren't we scared of light winds while we stay inside during a hurricane or wind storm? The velocity of those gangs of gas molecules have a dramatic impact on whether or not we will be able to stay standing on our feet. In fact, in just a 20 mph gust you can feel those gas molecules pushing you around.

Humans have been taking advantage of the energy in the wind for ages. Sailboats, ancient windmills and their newer cousins the electrical wind turbines, have all captured the energy in the wind with varying degrees of effectiveness. They all use a device such as a sail, blade or fabric to "catch" the wind. Sailboats use wind energy to propel them through the water. Windmills use this energy to turn a rod or shaft.

A simple equation for the **Power in the Wind** is described below. This equation describes a the power found in a column of wind of a specific size moving at a particular velocity.

P = Power in the Wind (watts)
 ρ = Density of the Air (kg/m³)
r = Radius of your swept area (m²)
V = Wind Velocity (m/s)
 π = 3.14

$$P = 1/2 \rho (\pi r^2) V^3$$

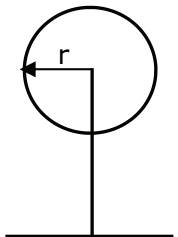

From this formula you can see that the size of your turbine and the velocity of the wind are very strong drivers when it comes to power production. If we increase the velocity of the wind or the area of our blades we increase power output.

The density of the air has some impact as well. Cold air is more dense than warm air so you can produce more energy in colder climates (as long as the air is not too thin!).

How much wind power is coming from a regular house fan?

V = 5 m/s (meters/sec)
 ρ = 1.0 kg/m³ (kilograms/cubic meter)
r = .2 meters
A = .125 m² (Area of Circle = πr^2)

$$\text{Power in the Wind} = \frac{1}{2} \rho A V^3$$

$$\begin{aligned} \text{Power} &= (.5)(1.0)(.125)(5)^3 \\ &= 7.85 \text{ Watts} \end{aligned}$$

There are 7.85 watts of wind power coming out typical house fan on high. Can our little turbines capture all of this power? Do some research on the **BETZ LIMIT** to find out.

Geared PVC Wind Turbine FAQ

Why won't the rotor spin when I put my turbine in front of the fan?

Check the orientation of the blades. Are your blades oriented in the same direction? Are they flat? Are they hitting the tower? Look at some pictures of old and new windmills to get some ideas about how to orient your blades.

Why does the gearbox seem to turn slowly or feel stiff? *The addition of the gearbox adds some friction to the system. Because of this you will need to make sure that your blades generate enough TORQUE (turning force) to overcome this friction.*

Why does the turbine slow down when I attach it to a load (pump, bulb, motor)?

Loading the generator forces it to do work. This makes it harder to push electrons through the circuit. The more load you add the harder it is for the generator to turn and the more torque you must generate from the blades. The only way to do this is to make bigger blades or relocate your wind turbine to a place with higher wind speeds.

Why are the readings on my multimeter all over the place?

Your readings may be fluctuating because the wind coming out of your fan is fluctuating. This can also be caused by blades that don't spin smoothly or change shape as they spin. Additionally, if your blades are not balanced, evenly distributed, or are producing unequal amounts of drag your readings will be irregular.

What are the best blades?

That is for you to figure out! Lots of testing and playing will get you closer to your answer.

Is a fan a good wind source to test with?

Well, it is the best we've got, unless you have a wind tunnel handy! The wind that comes out of a fan has a great deal of rotation and turbulence. It isn't very smooth. While it will still make your turbine spin it is not exactly like the wind outside. To see this turbulence, hold a short piece of thread in front of a fan and move it from the center out. It should head out straight all the time...does it?

Can I take my turbine outside? Can I leave it there?

You can certainly take, use and test your wind turbine outside. But unless you have a yawing turbine it will not track the wind and may not perform optimally. To make it work well you will have to continually face it into the wind. It is not a good idea to leave your turbine outside for too long. It is designed for basic lab tests and not to endure the rigors of the outdoor environment!

Based on the power in the wind equation it seems that longer blades should make more power. On my turbine this is not true!! WHY??

The blades on your turbine may be bigger than the diameter of the fan. If that is the case, the extra part is only adding drag so your blades will slow down. Additionally, if you design large blades poorly they will have lots of drag near the tips and slow down. This will negate any positive effect of the added length. Also, short blades spin faster than long ones, so if you are just recording voltage they will seem better. Try short blades with a load in series and see if they have enough torque to spin. In many cases they do not!