

About KidWind

The KidWind Project is a team of teachers, students, engineers, and practitioners exploring the science behind wind energy in classrooms around the US. Our goal is to introduce as many people as possible to the elegance of renewable energy through hands-on science activities which are challenging, engaging, and teach basic science principles.

While improving science education is our main goal, we also aim to help schools become important resources for both students and the general public, to learn about and see renewable energy in action.

Thanks to . . .

We would like to thank the Wright Center for Science Education at Tufts University for giving us the time and space to develop this idea into a useful project for thousands of teachers.

We would also like to thank Trudy Forsyth at the National Wind Technology Center and Richard Michaud at the Boston Office of the Department of Energy for having the vision and foresight to help establish the KidWind Project in 2004. Lastly, we would like to thank all the teachers for their keen insight and feedback on making our kits and materials first rate!

Wind for All

At KidWind, we strongly believe that K–12 education is an important foundation for promoting a more robust understanding of the opportunities and challenges that emerging clean energy technologies present.

The Wind for All program seeks to support teachers and students all over the globe who do not have the financial capacity to access our training programs and equipment. We believe that all teachers and students—regardless of where they live or what school they attend—must be part of the clean energy future.

A Note on Reproduction

This work may not be reproduced by mechanical or electronic means without written permission from KidWind, except for educational uses by teachers in a classroom situation or a teacher training workshop. For permission to copy portions or all of this material for other purposes, such as for inclusion in other documents, please contact Michael Arquin at KidWind: michael@KidWind.org



Our plastic components are made from recycled resins.



We source domestically whenever possible, and assemble and pack our kits in St. Paul, MN.



Proceeds from your purchase help us train and supply teachers.

FSC

Soy

Union

Table of Contents

Why wind?	4
Electricity	5
Power vs. energy	6
Electricity calculations	
Determining the power output of your turbine	9
Ohm's law	9
Computing power using voltage, current, and resistance	9
Output devices	
Multimeter	10
Power output board	11
Lightbulbs & LEDs	11
Small motors	11
Low-voltage water pumps	12
Supercapacitors	13
Fuel cells	14
Visual voltmeter	14
The power in the wind	15
Wind farms	
How to connect multiple wind turbines	16
The power of wind farms	17
The wind park effect	18
Where are wind farms?	18
Wind Turbine scale	19
What is the Betz limit?	19
More power: Improve your blades	
Advanced blades	21
Further research	
Short list for teachers	22
Intermediate & advanced books	22
Websites	23

Why wind?

Where does electricity come from?

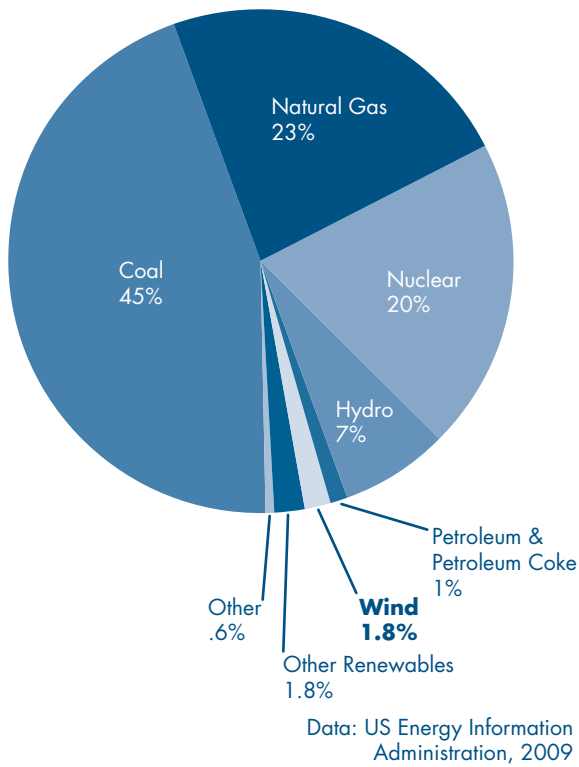

As interest in green, renewable energy has increased, the demand for—and investment in—wind energy has risen. There is now enough wind energy generated in the United States to power 14 million homes.

Of our current generation mix, about 2% of our energy is generated by the wind. That is double what we had three years ago: approximately 20,000 wind towers. Some industry leaders believe that by the year 2030 we will get 15–20% of our energy from the wind. Reaching this goal will take great effort and lots of scientists, engineers and technicians.

Why is there a push for renewable sources of electricity? State and local governments are reacting to public pressure to reduce negative environmental impacts to air, water, and wildlife from coal, nuclear, and large hydropower generation. Many state and regional governments are convinced that they need to significantly reduce the amount of carbon pumped into the atmosphere. If they do not make radical changes, they feel that their constituents will be adversely impacted by climatic change.

The benefits of this kind of widespread clean energy development would be monumental. In this scenario, we would reduce the cumulative amount of CO₂ put in the atmosphere by 7,600 metric tons by 2030. Close to 200,000 jobs would be created to manufacture, install and maintain these devices. Additionally, we would see huge reductions in both water use for power and negative health impacts from other pollutants. If done properly, we would see little or no increase in the cost of electricity and no decrease in reliability.

Greenhouse gas emissions intensity by electrical generation type.

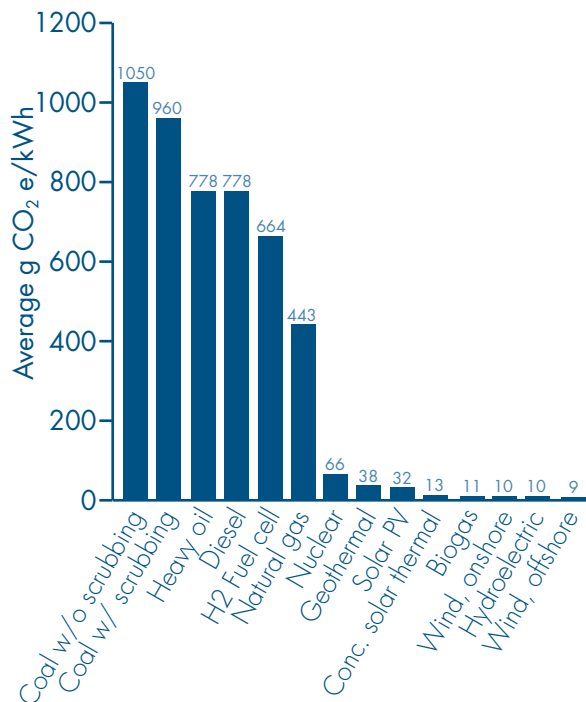

Basic concepts of wind power

Windmills have been used for centuries to pump water or move heavy rocks to grind seeds into grain. A wind turbine is the modern advancement of the windmill, instead using the wind to turn an electrical generator.

The force of the wind on the blades of a turbine causes them to move. As the rotor turns, it spins a driveshaft which is connected to a generator. The spinning generator converts mechanical (rotational) energy into the electrical energy we use every day.

The amount of electricity a wind turbine is able to produce depends on several variables: wind speed, the diameter (size) of the rotor, the density of the air, and the efficiency of the turbine. Wind speed, or "velocity," dramatically affects how much power is available in the wind.

Data: Sovacool, Benjamin K. "Valuing the greenhouse gas emissions from nuclear power: a critical survey." *Energy Policy*, Vol. 36, 2008, p. 2950.

Electricity

We tend to take the sources of our electricity for granted. When we flick a switch, we expect the lights to come on. But behind that switch are billions of dollars in investments and thousands of people making sure that for the consumer, it is as simple as that—flicking a switch.

What is electricity?

The most common type of electricity is the flow of electrons through a conductor, which is a material consisting of atoms that allow electrons to move freely through it. An example of a good conductive material is copper, which is used in most common electrical wiring. When we "generate" electricity, we produce voltage, which causes electric current to flow in a circuit, "pushing" the free electrons in a common direction through the conductors that make up that circuit. Today's electrical infrastructure allows us to control and distribute electricity to our homes, schools, and countless other buildings so we can use it to do work.

We use electricity to illuminate light bulbs, power televisions and computers, and operate refrigerators, air conditioners, toasters, video games, and more.

Generating electrical energy is not simple; we have to convert it from other sources of energy like fossil fuels, wind, or sunlight. Fossil fuels such as coal, oil, and natural gas emit thermal energy when burned. Air molecules from wind have kinetic energy, and sunlight gives off energy from heat and light, both of which can be harnessed. Wind, solar, and fossil fuels are known as "primary" energy sources. Primary energy sources are typically converted into electricity using an electrical generator.

How is electricity generated?

A generator is a device that converts mechanical energy into electrical energy. In 1831, Michael Faraday discovered that while a magnet is moving inside a coil of wire, an electrical "voltage" is produced between the ends of that wire. This discovery, known as Faraday's law, demonstrated that a relationship exists between electricity and magnetism.

A typical generator uses powerful magnets and many coils of copper wire. Faraday's law tells us that a magnet moving within a coil of wire has the potential to cause electrons to flow in a circuit. It is also possible to move the coil of wire within a magnetic field to generate electricity.

Most generators consist of a rotating shaft to which coils or magnets are attached. In the case of a wind turbine, rotating blades designed to catch wind are fixed to this shaft.

Using generators, we are able to capture mechanical energy and convert it to electrical energy, powering the electrical devices we use every day.

Residential electricity use

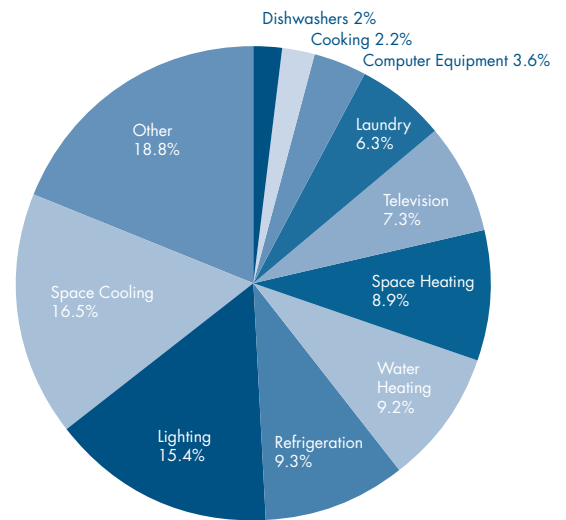

Data: US Energy Information Administration, 2009

A simple generator

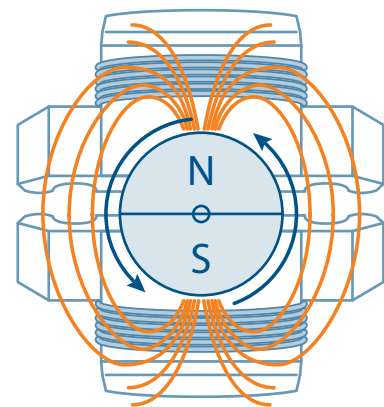

A magnetic field moving across a wire coil induces an electric current along the wire.

A practical comparison

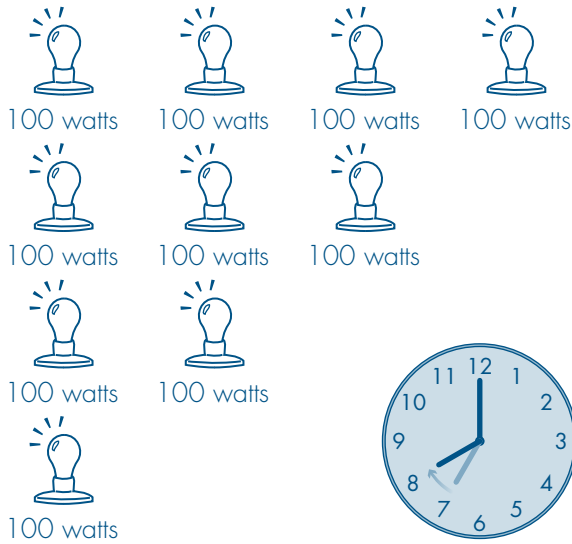

Power

Ten 100 watt (W) bulbs
 $10 \times 100 = 1000 \text{ W}$
 $= 1 \text{ kW}$

Energy

These ten 100 W bulbs lit for 1 hour use 1 kWh.

Typical residential rate for electricity in US:
 6–20¢ per kWh.

Power vs. energy

There are two important terms of measurement used to discuss electricity: electrical power and electrical energy. Power is the rate at which energy is used. Energy is the total amount, or quantity, of work performed by an electrical device.

Power is a rate—an amount of work per unit of time. Some other examples of rates are miles per hour, gallons per minute, and dollars an hour.

The unit of electrical power is the watt. One watt is roughly the amount of power needed to raise a small apple (100 grams) to one meter of height in one second. Because a watt is a small unit, kilowatts (kW), referring to 1,000 watts, and megawatts (MW), or 1,000,000 watts, are often used. How “powerful” must something be to lift one thousand or one million apples one meter in one second? Most utility scale wind turbines are capable of generating between 1.5 and 3 MW!

The total amount of energy a device uses depends on how much power it needs to operate and the amount of time it is consuming that power. A powerful car does not use any gas parked in the garage all day! Energy is the amount of work done by a device, a quantity rather than a rate.

Electrical energy can be measured in watt-hours, kilowatt-hours (kWh), or megawatt-hours (MWh). To determine how much energy an appliance uses, take the number of watts of power it needs to operate and multiply that by the length of time it operates—watts (or kW or MW) times hours. People pay electrical bills based on how many kilowatt-hours of energy they use in a month. Typical US homes use 1000–1500 kWh per month.

Power and energy from wind turbines

Wind turbines are often rated by how much power they produce at peak output. A 1.5 GE XLE will produce 1,500,000 W in a 35 mph wind. A 10kW Bergey will produce 10,000 W in the same wind. All turbines are rated using power curves. These curves describe the power output of a wind turbine over a range of wind speeds. As you can see, at around 3 meters per second the turbine comes on and starts to rapidly produce power. This is called the cut-in speed. At around 13 m/s the curve flattens because the generator cannot produce any more power or it will be damaged. Turbines have mechanisms to slow down or shut off when high winds threaten to damage them. This turbine shuts off at 18 m/s.

Knowing the power a turbine *can* produce is helpful, but it does not tell you how much energy the turbine *will* produce. You must also know how fast the wind blows and for how long the wind blows that fast. A huge wind turbine in a place without wind makes no energy! A small wind turbine in a windy place produces lots of energy. When planning a wind turbine, the amount of energy it will actually produce is more important than its maximum power output.

Sample power curve

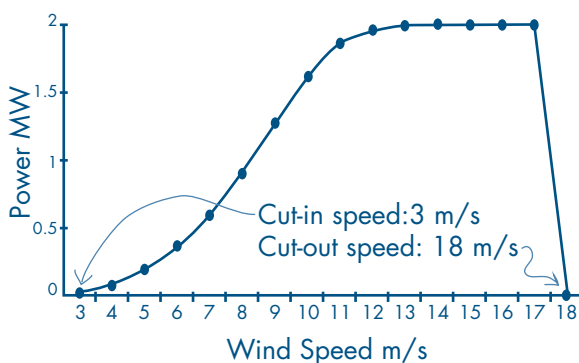

1 m/s = 2.2 mph

What is voltage?

Voltage (measured in volts), is also called "potential difference" or "electromotive force" (EMF) and is a measure of the amount of "potential energy" available to make electricity flow in a circuit. It is the electric "pressure" causing the current to flow. Most electric appliances need a particular voltage to work properly. For example, a watch or cell phone requires only a few volts to operate, while a typical home appliance which plugs into a wall outlet requires in the range of 120 volts. Too little or too much voltage can cause problems: if not enough voltage is available (such as during a power "blackout" or "brownout") the appliance may not operate correctly, if at all. Too much voltage (from "spikes" on the power line, for example) could cause the appliance to be damaged.

What is current?

Electric current is a measure of the rate at which electric charge (electrons) are flowing through a circuit. It is given in the unit of amperes ("amps"). Smaller amounts of current are often stated in "milliAmps" (mA). A mA is 1/1000 of an amp. Large amounts of electric current are needed to operate high power consuming appliances such as air conditioners, large motors and heaters. Smaller amounts are needed to run low power devices such as TV's, home computers and cell phones. It usually requires a large voltage to cause a high amount of current to flow in a circuit, but not always. For example, your car battery can produce 500-1000 amps of current for short periods of time at only 12 volts.

We always speak of electric current flowing through a single point in a circuit, whereas we refer to voltage existing across or between two points in a circuit.

What is resistance?

Electrical resistance is the opposition to the flow of electricity. Measured in "ohms," it reflects how much electric "pressure" (voltage) is required to push a given amount of current through a device or part of an electric circuit.

If it takes a lot of voltage for current to flow through the device, its resistance is high. If current flows easily, even with a small voltage applied, its resistance is low. Materials with low resistance and which allow easy passage of electricity are referred to as conductors, such as copper, silver, and aluminum. Materials which strongly oppose the flow of electricity are called insulators, e.g. glass, porcelain, plastic, wood, and air. Materials known as "semiconductors" allow electricity to flow through them easily in some situations, but not in others. A well known example is silicon, the "building block" of transistors and integrated circuits (chips). Few devices (except resistors) have a fairly constant resistance. The resistance of most conductors increases with temperature.

Water analogy for voltage, current & resistance.



High voltage = high pressure
Low voltage = low pressure

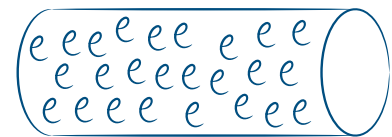

More Current = more electron flow

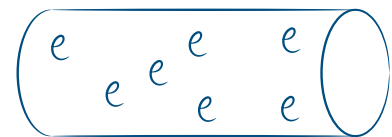

Less Current = less electron flow

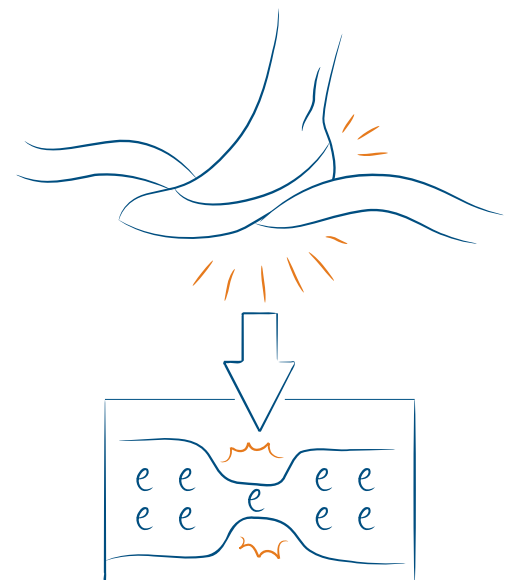

Higher resistance needs more voltage to push electrons through

Load

A load is anything that consumes energy. An electrical load consumes electric energy. When electric current flows through a load, electric energy is often converted to some other form of energy. For example, when you turn on a light switch, electric energy is converted by the bulb to light and heat. In this case, the light bulb is the "load" in the circuit. An electric motor is a "load" which converts electric energy to mechanical energy. A loudspeaker is a load that converts electric energy to sound energy.

Usually, the more electric current that is flowing through a load, the more power it is consuming. If a device has a high electrical resistance, the amount of current that can flow through it is low. So, high resistance tends to mean less power consumed. Loads that consume much power (low resistance) are referred to as "heavy" loads, and those that require little power (high resistance) are "lightly loaded." If no electricity is flowing at all, such as when a light switch is turned off, there is no load whatsoever on the circuit (since no power is being consumed).

How to set up a wind turbine experiment

Set up the tower with one leg facing away from the fan. For extra stability when you're using big blades or high speed wind, tape the base to the floor or desk.

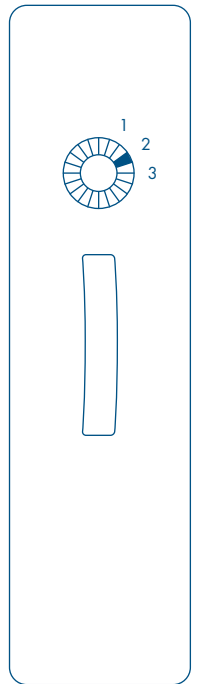
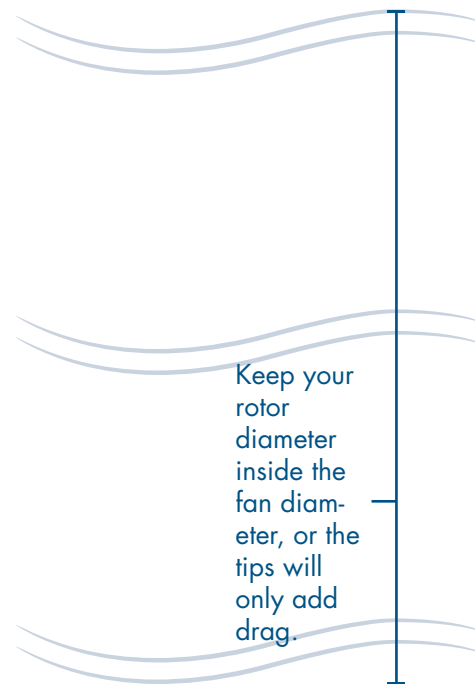
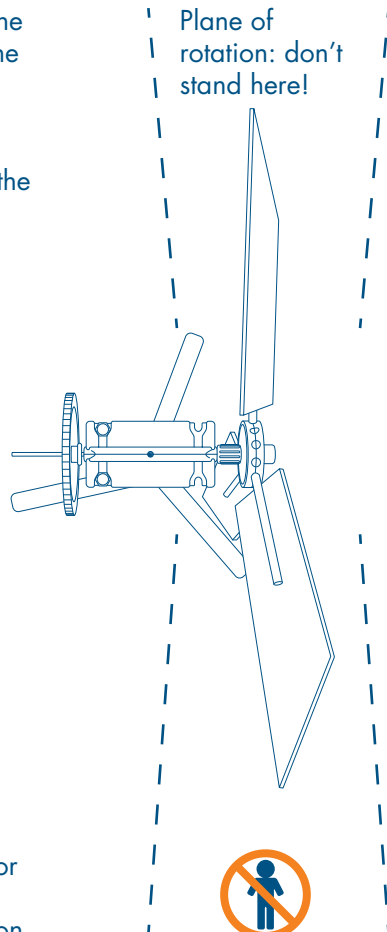

 Stand behind or in front of the plane of rotation.



Use a large box or circular fan, for strong, consistent wind. A hairdryer or desk fan won't do it!

Electricity Calculations

Determining the power output of your turbine

These calculations are more advanced than just measuring voltage or current alone and require you to have learned how to use your multimeter properly. During these calculations, be mindful of the units to which your multimeter is set. Make sure it is set to volts or amps, not millivolts or milliamps. If you do not use the correct units, your calculations will come out wrong.

The equation for electrical power

$$P = V \times I$$

P = power in watts

V = voltage in volts

I = current in amps

Ohm's law

Using Ohm's law, multimeter measurements, and resistors, we can do some simple calculations to determine current output. The foundation of these basic electrical computations is referred to as Ohm's law, after the German physicist Georg Ohm. In 1827, Ohm described measuring voltage and current through simple electrical circuits containing various lengths of wire.

Ohm's law

$$V = I \times R$$

V = voltage in volts

I = current in amps

R = resistance in ohms

Using algebra, we can rearrange this equation to determine the current from voltage and resistance:

$$I = V/R$$

Computing power using voltage, current, and resistance

It can be hard to calculate power by measuring current and voltage simultaneously. You need two multimeters and lots of clip cords. In certain situations, we can make this easier, using Ohm's law.

Remember: power = voltage \times current

If we have a circuit with a known resistance, we can use Ohm's law to replace the current measurement I with V/R and derive the equation below.

$$P = V \times I$$

$$P = V \times (V/R)$$

$$P = (V \times V)/R$$

$$P = V^2/R$$

If we know the voltage that our turbine is producing and the resistance in the circuit, we can determine our power output.

EXAMPLE

Your KidWind MINI is producing 3 V at 50mA. How much power is your turbine producing?

$$P = V \times I$$

$$P = 3 \times .050$$

$$P = .15 \text{ W}$$

$$P = 150 \text{ mW}$$

EXAMPLE

$$\text{Current} = V/R$$

$$\text{Resistor} = 50 \Omega$$

$$\text{Voltage} = 1 \text{ V}$$

$$I = V/R$$

$$= 1/50$$

$$= 0.020 \text{ A}$$

$$= 20 \text{ mA}$$

EXAMPLE

$$V = 3 \text{ V}$$

$$R = 50 \Omega$$

$$P = V^2/R$$

$$\text{Power} = (3 \times 3) / 50$$

$$= 9/50$$

$$= 0.18 \text{ W}$$

$$= 180 \text{ mW}$$

Measuring DC Voltage

This meter is measuring 1.5 volts.

Measuring Current

This meter is measuring 11.8 mA.

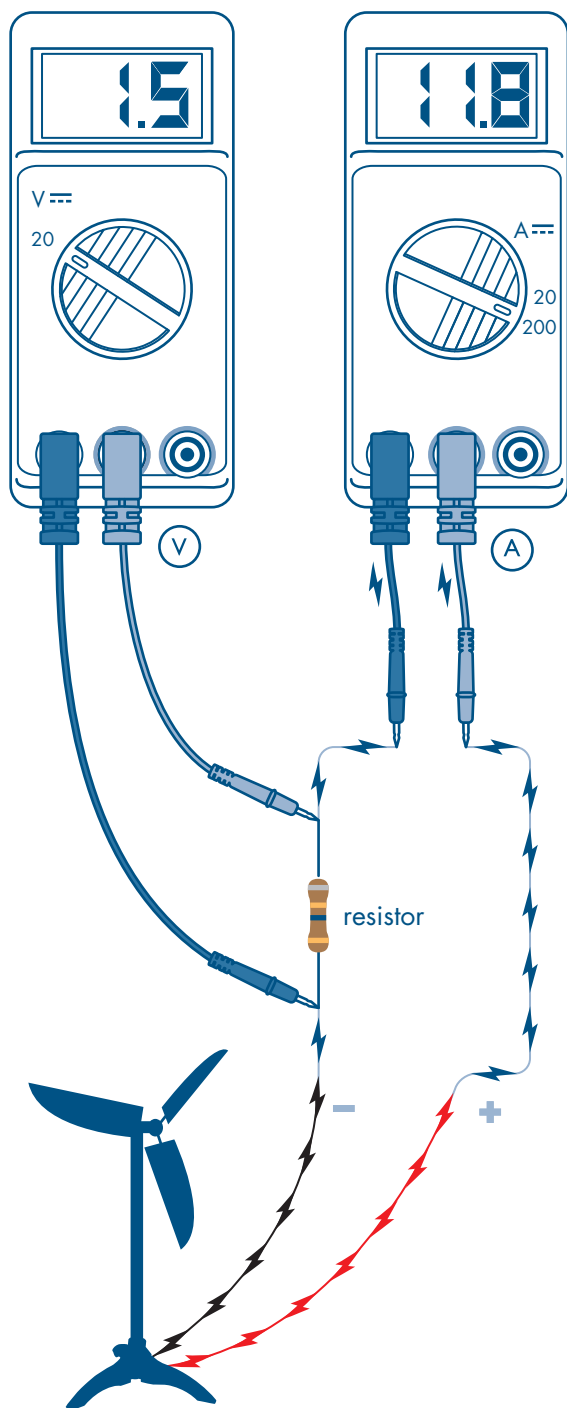

Output devices

Wind turbines produce electricity, and the best way to understand this is to hook your turbine up to some load or an output device. Our kits come with a variety of different output devices and more are available.

Different turbines are capable of powering different loads. The Basic Turbine and the MINI Turbine are *direct drive* turbines. They do not produce as much power as the Geared Turbine or the ALTurbine, which both use gear trains to increase generator shaft speed. We sell many output devices, but try hooking up other small loads you have, too!

Multimeter

Using a multimeter, you can quantify the voltage and/or current your turbine is producing. Learning how to accurately measure the voltage and current for a range of situations will help you compare data when testing blades, comparing gearing, or changing any other variables on small turbines. You will also need this information if you want to calculate the power your turbine produces.

Measuring voltage

Attach the wires from the generator to the multimeter. Polarity is not relevant at this point.

To check the voltage, select DC volt (V) and set the number to 20.

Place your turbine out in the wind or in front of a fan and let it spin. It is normal for the voltage readings to fluctuate. Voltage output is often unsteady because of the inconsistent nature of the wind or unbalanced blades.

Voltage is related to how fast the DC generator is spinning. The faster it spins, the higher the voltage. When there is no load on the generator, it has little resistance and can spin very fast.

You can measure voltage with no load, but it is more realistic to place a resistor in the circuit and measure the voltage across the resistor. We commonly use 10, 30, 50 or 100 ohm resistors when measuring voltage on KidWind Turbines.

Measuring current

To calculate your turbine's power output, you will need to measure current as well. To collect amperage data, you will need to place a load, preferably a resistor, in series with the multimeter so that the generator is forced to do some work.

When measuring current, you are monitoring how many electrons are being pushed through the wire by the turbine. We measure current from our turbine in milliAmperes. Recall that $1A = 1000mA$

MEMENTO MORI

Turn off the multimeter when you are done, or the battery will die!

Build your circuit with a resistor and then place the multimeter in series. Set the meter to 200 or 20 mA, which is a typical range for our devices. If your turbine produces more amperage, you can turn the dial to a higher range.

The current that your turbine produces depends on the load placed in the circuit and the torque your blades are generating.

Sound & light panel

Attach the wires of the turbine to those of the sound & light panel. The switch on the board allows you to use the electricity created by your turbine to light an LED bulb or play a melody.

Light bulbs & LEDs

You can use your turbine to light small incandescent bulbs or LEDs. LEDs require much less power than incandescents, so they are easier for your turbine to light. You can also use bulbs from flashlights, but be sure they are designed for low voltage and current. Strip the leads before attaching them to your turbine.

LED lights need about 1.75 volts to light, but very little amperage. LEDs also require that the electricity runs in the right direction. If your turbine is generating more than 2 volts but the LED is not lighting, try reversing the turbine output wires that are connected to the bulb.

We recommend always using a resistor in series with the LED, since too much current can burn LEDs out.

Small motors

The power requirements of most small DC motors are pretty minimal, especially if they have a low voltage rating. Look for small DC motors in broken electric toys.

Attach the leads from your turbine to the short leads coming off the motor. When your turbine is operating, the motor will spin. You need around 0.6–0.8 volts to power a small motor.

Selected output devices for KidWind turbines

1. Wind turbine generator
2. Alligator clip cords
3. Digital multimeter
4. Graduated cylinder, with low voltage pump
5. Incandescent light
6. LED
7. Propeller
8. Visual voltmeter
9. Capacitor
10. Sound & light panel.

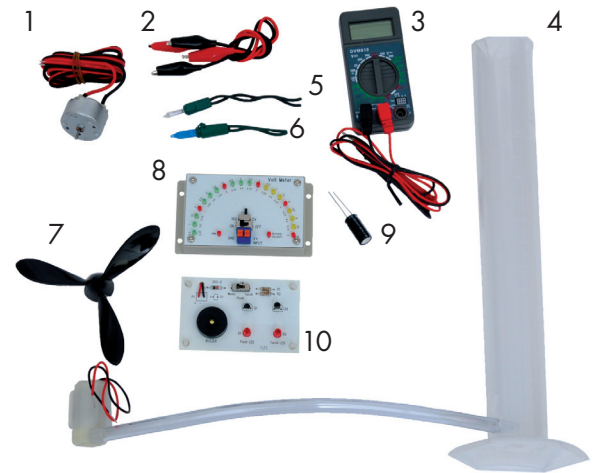

OUTPUT PACK

Our full turbine kits include these output devices:

- *Alligator clip cords—These help attach your turbine to various load devices. Attach the metal clips to the leads of the device.*
- *DC motor*
- *LED light bulb*
- *Incandescent light bulb*
- *Sound & light panel (class packs and KidWind MINI)*
- *Propeller—You can attach this propeller to your wind turbine generator shaft. With good wind this setup will make enough voltage to light an LED bulb.*
- *Supercapacitor*
- *Protractor—Okay, not an output device, but we throw it in the output pack, to help you measure blade angle.*

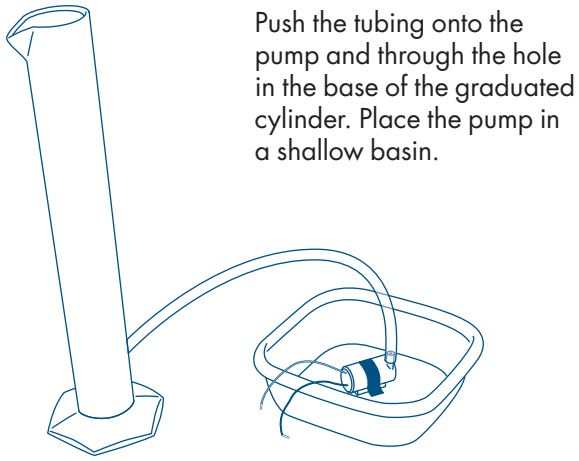

Push the tubing onto the pump and through the hole in the base of the graduated cylinder. Place the pump in a shallow basin.

Attach the leads from the pump to those from your turbine. Fill your basin with colored water.

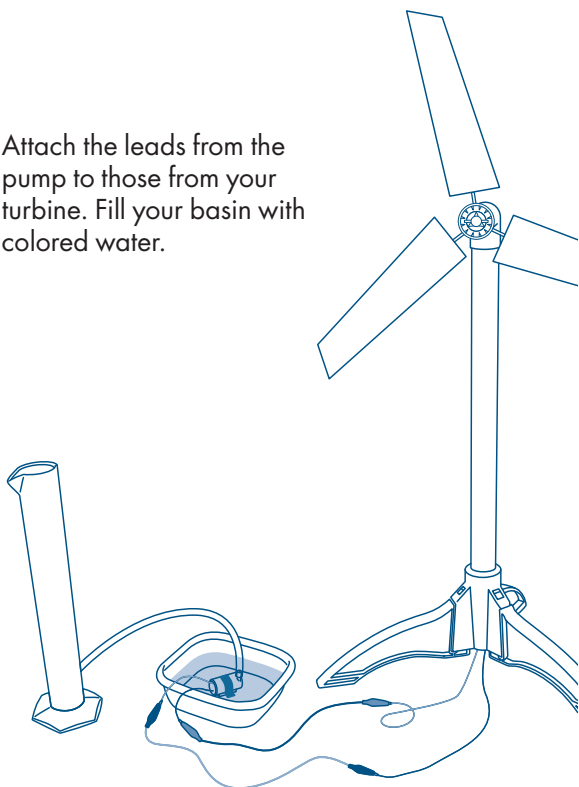

Run the turbine; how high can it pump water? How fast will it pump a given volume? Can you get it to overflow? Better blades provide more power, and will be able to pump better.

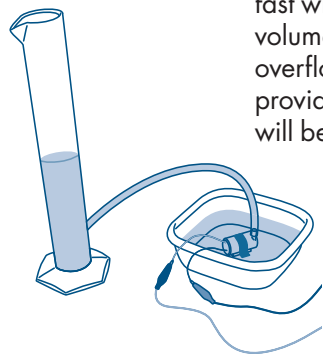

Low voltage water pumps

KidWind uses a low-voltage water pump that works well with our wind turbines. You need to produce around 2.0 V for this pump to run well. A good deal of torque is needed too, since pumping water requires a lot of power. This is one of our favorite demonstrations using wind energy. We typically hook it up to a graduated cylinder to see whose turbine blades can pump the most water in 1–2 minutes! Another cool thing is that this device models how wind power is often used around the world. Keep in mind, our turbines will not run a 6 V or 12 V aquarium pump.

Setting up the pump

First, secure the pump in a water bath. Any plastic dish will work, but we recommend using one that has low sides and is pretty wide.

Secure the pump in the bath using some masking or duct tape. Make sure you do not cover the intake areas on the pump.

Fill the water bath with colored water. Using food coloring in the water will make the pumping more dramatic. This pump can be submerged, so you can put it underwater.

Attach the wires from the water pump to your wind turbine. Now you are ready to use your mini pump system!

What's next?

Test blade designs with the water pump. If you design the blades well, and the wind speed is fast enough, the pump will slowly start to push water into the graduated cylinder.

To compare different types of blades, you can let your pump work for a set amount of time (say one minute) and record how much water is pumped. Place a different set of blades on the turbine and repeat the test. Compare the power output of the different blades by recording the water pumped during each trial.

The electrical output of the wind turbine can also be calculated by letting the pump and cylinder reach an equilibrium. At some point, you might observe that the water level is neither rising nor falling. The weight of the water in the column is then equal to the physical output of the pump.

Record this equilibrium point and compare this data to a different set of blades. If you are really making juice, you might just overflow the cylinder.

Supercapacitors

Like a battery, a capacitor can store and release electrical energy. Capacitors function differently from batteries, however.

Unlike a battery, regular capacitors do not use chemical reactions. Instead, two metal plates separate negative charges from positive charges creating voltage. One surface (plate) has a large over-abundance of electrons; the other surface has a deficit of electrons. This imbalance of charge creates an electric field between the positively charged plate (with the deficit of electrons) and the negatively charged plate (with the abundance of electrons). Supercapacitors (also called ultracapacitors) are constructed differently from regular capacitors. Supercapacitors separate and store charge using layers of charcoal, as well as a very thin layer of electrolyte, an electrically conductive liquid. Whereas capacitors function electrostatically, supercapacitors function electrochemically due to the presence of electrolyte.

Supercapacitors have several benefits. They can be cycled hundreds of thousands of times without degradation, and can be rapidly charged and discharged. Supercapacitors are used with wind turbines to even out the intermittent power supplied by wind.

Charging supercapacitors

Charging a supercapacitor with renewable energy is easy, but there are some important steps to follow. Supercapacitors are polarized, meaning they have positive and negative terminals. Because of this, you have to properly connect your electricity source (wind turbine, solar cell, etc.) to the supercapacitor. The longer lead is always the positive (+) terminal.

Next, determine the proper polarity of your turbine or solar cell (see sidebar on page 16). The positive lead from your wind turbine should attach to the positive lead on the supercapacitor. The negative turbine lead goes to the negative lead on the supercapacitor. Once you have the correct polarity, you can start charging the supercapacitor!

Turn the fan on to start your turbine and wait about 1 ½–2 minutes. You can test the capacitor while it is charging by hooking it to a voltmeter and watching the voltage increase. When the voltage stops rising, the capacitor is charged.

USE YOUR SUPERCAPACITORS

Supercapacitors can power:

- LED light bulbs
- Incandescent bulbs
- Motors to drive:
 - Cars
 - Boats
- The KidWind low-voltage water pump

Supercapacitors to the rescue!

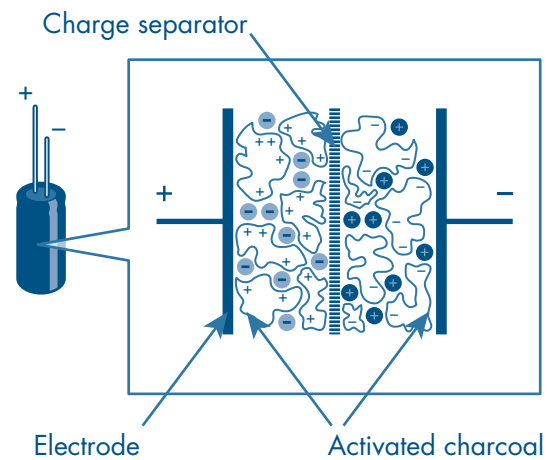

Supercapacitors—or "electric double-layer capacitors"—work by separating charges and storing them in parallel layers of charcoal (carbon). Even in very thin sheets, the activated charcoal has a large surface area, so it can store lots of charge carriers in a compact space. Manufacturers roll these sheets up into tightly-packed cylinders, creating high-density supercapacitors.

IMPORTANT CONCEPT

Capacitors store energy. Energy = power × time. To collect a lot of energy, you need a high power level, long charge duration, or both. The same holds true for discharging the capacitor. The rate that energy will be used from the capacitor is dependent on how much power is being consumed from the capacitor multiplied by how long it is being consumed. See page 6 for more on energy or power

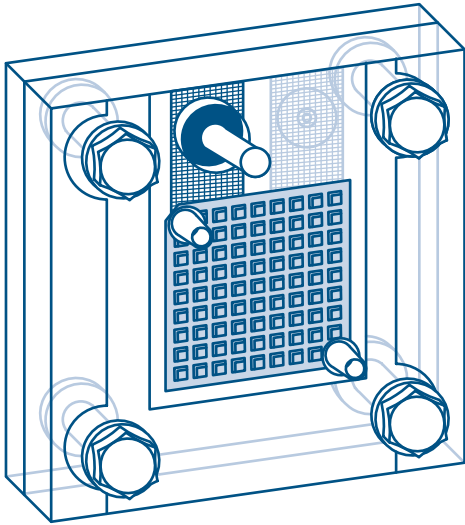

Reversible fuel cells can electrolyze water into hydrogen and oxygen, and later recombine the stored gasses, producing an electric current.

Fuel cells

Remember that making hydrogen requires energy for breaking bonds. The advantage of hydrogen is that it can be stored and transported, unlike the energy produced by wind turbines. Fortunately, we can use clean energy sources like wind to produce the hydrogen—creating a clean, transportable source of electricity with no hazardous emissions.

Using a geared wind turbine, you can generate enough electricity to run a simple fuel cell. When you run electricity through the fuel cell, it will separate water into hydrogen and oxygen to storage chambers which can be recombined to generate electricity. You could use this stored chemical energy to run the mini water pump, power a small DC motor, or you can attach it to a fuel cell car and see how far it travels on wind-produced electricity.

To run this device, your turbine needs to produce at least 1.75 V. More than 2.0V for sustained periods can damage your fuel cell, so be careful!

Visual voltmeter

The LED voltmeter indicates the DC voltage connected to the input terminals. It measures up to 10V, and switches between a 5V or 10V scale.

The numbers above the LED bulbs correspond to the 10 V scale, and those below the bulbs are for the 5 V scale. When the input voltage reaches a certain level, the LED bulb for that level will light. The higher the input voltage, the more LEDs light up.

This device has positive and negative terminals, so it is important to plug the correct lead wires into the correct terminal. If you do not have the polarity correct, the “Reverse Polarity” bulb will light up. Simply reverse the leads so that they go into opposite terminals.

To attach your leads, push down on the orange buttons above the terminals and insert the stripped wires from your model wind turbine, solar cell, fuel cell, or hydro turbine. This voltmeter requires 4 AAA batteries.

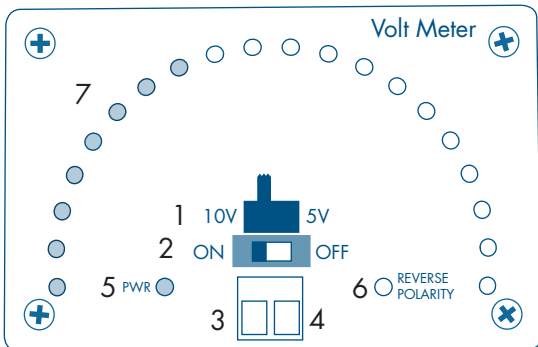

1. Voltage scale selector
2. On/Off switch
3. Negative (-) terminal
4. Positive (+) terminal
5. Power light
6. Reverse polarity light
7. Voltage indicator lights

The power in the wind

If a large truck or a 250 lb linebacker was moving toward you at a high speed, you would move out of the way, right?

Why do you move? You move because in your mind you know that this moving object has a great deal of energy as a result of its mass and its motion. And you do not want to be on the receiving end of that energy.

Just as those large moving objects have energy, so does the wind. Wind is the movement of air from one place on Earth to another. That's the motion part.

What is air? Air is a mixture of gas molecules. It turns out that if you get lots of them (and we mean lots of them) together in a gang and they start moving quickly, they will give you a serious push. Just think about hurricanes, tornadoes, or a very windy day!

Why aren't we scared of light winds, but we will stay inside during a hurricane or wind storm? The velocity of those gangs of gas molecules have a dramatic impact on whether or not we will be able to remain standing on our feet. In fact, in just a 20 mph gust, you can feel those gas molecules pushing you around.

Humans have been taking advantage of the energy in the wind for ages. Sailboats, ancient windmills, and their newer cousin the electrical wind turbine, have all captured this energy with varying degrees of effectiveness. They all use a device to "catch" the wind, such as a sail, or blade. Sailboats use wind energy to propel them through the water. Windmills use this energy to turn a rod or shaft.

A simple equation for the power in the wind is described below. This equation describes the power found in a column of wind of a specific size moving at a particular velocity.

$$P = \frac{1}{2} \rho (\pi r^2) v^3$$

P = power in the wind (watts)

ρ = density of the air (kg/m^3)

r = radius of your swept area (m)

v = wind velocity (m/s)

π = 3.14

From this formula you can see that the size of your turbine and the velocity of the wind are very strong drivers when it comes to power production. If we increase the velocity of the wind or the area of our blades, we increase power output.

The density of the air has some impact as well. Cold air is more dense than warm air, so you can capture more energy in colder climates.

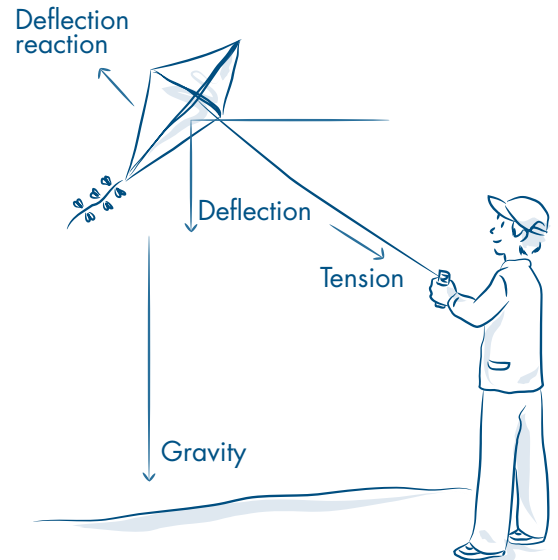

There is power in the wind. You can see this when you fly a kite. The force of the wind must overcome the force of gravity to keep the kite aloft.

SAMPLE

How much power is available to a wind turbine with 1.4 m blades, if the wind speed is 7 m/s and the air density is 1.1 kg/m^3 ?

$$P = \frac{1}{2} \rho (\pi r^2) v^3$$

$$P = .5 \times 1.1 \text{ kg}/\text{m}^3 \times 3.14 \times 1.4^2 \text{ m} \times 7^3 \text{ m}/\text{s}$$

$$P = .5 \times 1.1 \text{ kg}/\text{m}^3 \times 3.14 \times 1.96 \text{ m} \times 343 \text{ m}/\text{s}$$

$$P = 1,161 \text{ watts}$$

$$P = 1.2 \text{ kW}$$

DETERMINING POLARITY

The polarity of the leads on a turbine is determined by the direction the blades are spinning. To determine the proper polarity of your turbine, you will need to connect it to a multimeter. If your voltage reading is positive, the lead connected to the red multimeter wire comes from the positive terminal. If the voltage reading is negative, the lead connected to the red multimeter wire comes from the negative terminal. It is a good idea to mark your wires with tape so you know which is positive and which is negative.

Polarity is determined by the direction the generator is spinning. If you change the pitch of the blades so that they start spinning in the opposite direction, the turbine's polarity will switch, too.

WIND FARM CIRCUITS ARE ACTUALLY MORE COMPLICATED...

In the real world, turbines in a wind farm are not directly connected to each other. They are wired through an interconnect device which makes sure the electrical output of one turbine does not interfere with the electrical output of another turbine.

When you wire your KidWind turbines in series, you are forcing the current from one turbine to go through the generators of the other turbines. This can interfere (a lot!) with their operation. Why? Because in each generator, the movement of magnets past the wire windings induces a current. If you send the electrical output of the neighboring turbine through the wire windings (where you are trying to induce a current to flow), you may "mess up" the induced current.

When the turbines are connected in parallel, they usually interfere less with each other. Why? You are not forcing the electrical output of one turbine to flow through the generator of the other turbines. However, if one turbine has a greater output than another, the current may try to flow from one into another; this can be helped with the use of a diode, which allows the current to flow in only one direction.

Wind farms

A wind farm is a collection of wind turbines in the same location. This may also be called a "wind power plant," since many wind turbines working together can produce a lot of electricity—just like coal or nuclear power plants. Wind turbines are often grouped together in wind farms because this is the most economical way to create electricity from the wind. In other words, wind farms give us the most power for our buck! Wind farms are one of the most affordable sources of electricity today, and may soon become the cheapest form as technology advances and fossil fuels become less abundant.

You can build your own mini wind farm using KidWind turbines!

How to connect multiple wind turbines

When making a wind farm, you can choose to wire your turbines in series or in parallel. Before you build a wind farm, you will need to hook up the wires correctly; to do that, you need to find the polarity of each wire coming from your turbine (see sidebar). Finding the polarity means figuring out which wire is positive (+) and which is negative (-).

The polarity of the wires is determined by the direction your blades are spinning. Changing the direction the generator is spinning will change the polarity of your wires.

Parallel

In the parallel circuit, all the negative wires from the turbines are wired individually to the negative (black) side of the meter and/or the load. All the positive wires go separately to the positive lead of the meter or load.

You can see that the current from each turbine is able to travel a separate path through the circuit.

Each turbine in parallel increases current, but not voltage in the circuit.

Series

If you are connecting the turbines in series, connect the wires of the turbines from positive to negative, making one continuous loop through the circuit.

Think of negative as the "in" and positive as the "out," with electricity flowing out of each turbine and into the next.

In a series circuit, there is only one pathway for the current to travel. The leads are connected negative to positive to negative to positive and so on. With your meter measuring voltage, you will see that each turbine added to the series will increase the voltage. If you measure current through the circuit, you will see it is unchanged.

The power of wind farms

Recall the power in the wind equation:

$$P = \frac{1}{2} \rho (\pi r^2) v^3$$

What are we changing in this equation when we add more wind turbines and create a wind farm? The density of the air never changes, and adding more turbines will not change the wind velocity. With a wind farm, you are increasing the radius of your swept area (r).

Assuming your blades are all the same size, having three wind turbines, as opposed to just one, will effectively triple your swept area! Of course, due to resistance and losses, we cannot expect to get exactly three times the power. What are some of the causes of inefficiency and losses that reduce your total power?

If you use a multimeter to record voltage and current as you add wind turbines to your wind farm, you will find some interesting results.

When you have multiple turbines wired in series, the voltage will increase with each additional turbine, but the current will stay the same!

If you wire the turbines in parallel, the current will increase with each additional turbine, but the voltage won't change!

$$\text{Power (watts)} = I (\text{current}) \times V (\text{voltage})$$

Three turbines in parallel will produce the same power as the same three turbines wired in series. If you put three turbines in series, you will triple the voltage with the same current. Three turbines in parallel should triple the current with the same voltage.

P = power in the wind (watts)

ρ = density of the air (kg/m^3)

r = radius of your swept area (m^2)

v = wind velocity (m/s)

π = 3.14

MINI wind farm, wired in series

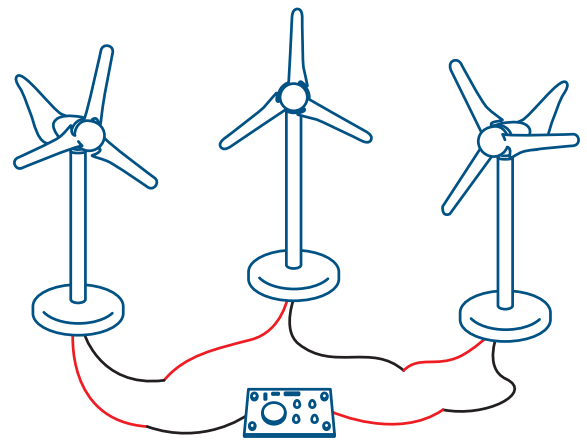

MINI wind farm, wired in parallel

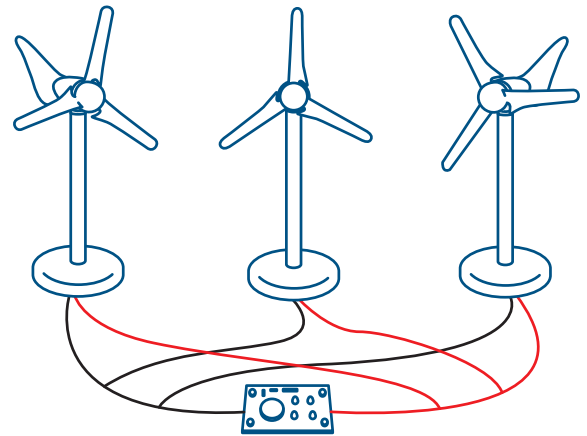

KidWind Turbine—1 watt



2.5 kW Turbine—2,500 watts



1.5 MW Turbine—1,500,000 watts



Swept area is a very important part of the power in the wind equation. It's why utility scale turbines are huge, and why your KidWind turbine can't power your house.

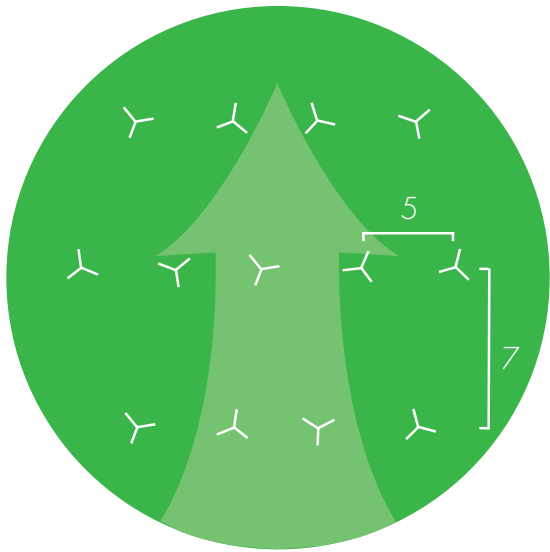

This wind farm was designed to minimize “wind park effect.”

The wind park effect

If multiple wind turbines are placed too close to one another, the efficiency of the turbines will be reduced. Each wind turbine extracts some energy from the wind, so directly downwind of a turbine, winds will be slower and more turbulent. For this reason, wind turbines in a wind farm are typically placed 3–5 rotor diameters apart perpendicular to the prevailing wind, and 5–10 rotor diameters apart parallel to the prevailing wind. Energy loss due to the “wind park effect” may be 2–5%. What effect do you find when you move the turbines around in your miniature wind farm? Try placing a few turbines very close together, or right behind each other. Do you notice a reduction in the efficiency of your wind farm?

Where are wind farms?

As of 2011, all of the wind farms in the US are on land. Wind velocity greatly affects the power in the wind, so it makes sense to build wind farms in places that are very windy. Some of the windiest places on land in the US are the Great Plains (the “wind belt”), mountainous areas, and coastal areas. Currently, the majority of wind turbines installed in the US are in the Great Plains from Texas to North Dakota.

Installed wind capacity by state (megawatts)

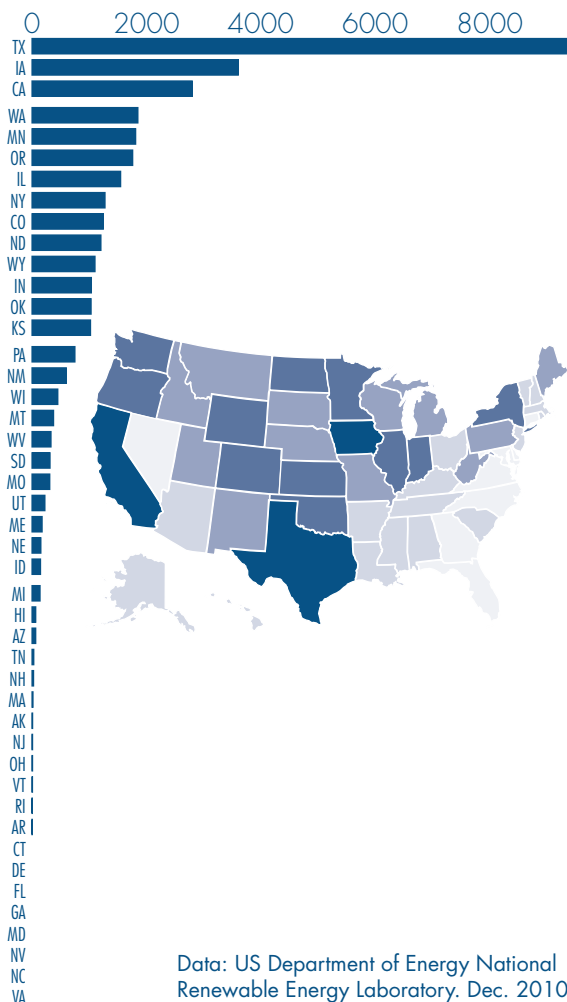

In Europe, many wind farms have been built out to sea—miles from land. Consistent, fast, and smooth offshore wind means that these wind farms can make a lot of power. In the future there may be many offshore wind farms built around the US. Offshore turbines can be much larger than turbines built on land. Typical offshore turbines have a rated capacity of 2.5–5 MW, while the average onshore turbine is rated at 1.5–2.3 MW.

Offshore wind power is very promising, as the turbines can be placed closer to the people that use the power. Forty-eight percent of the US population lives within 50 miles of the ocean. The basic concept would be to build large wind farms in the ocean or great lakes and run cables back to shore.

In 2010, Cape Wind was approved to begin constructing the first offshore wind farm in the US. Offshore wind farms have been very controversial in many places due to their visual impact. Cape Wind, for example, has faced nine years of lawsuits, debates, and strong opposition largely due to the aesthetic impact of the project.

Currently, all offshore wind turbine foundations are in the ocean floor, but some scientists and engineers are studying floating turbines! Floating wind turbines could be placed in deeper waters where winds are even stronger and out of view from people who live on the coast. While prototypes have been installed in the North Sea, these devices are years away from widespread application.

Wind turbine scale

Wind turbines come in all shapes and sizes. The smallest wind turbines produced have a rotor diameter of 1 meter and only produce enough power to charge a few 12 volt batteries—or about 100 watts. A wind turbine that could power your whole house is still considered “small.” This wind turbine might have a rotor diameter of 7 meters and could produce 10 kW (10,000 watts) in a 35 mph wind.

A typical “large,” or utility scale, wind turbine has a rotor diameter of 80 meters and stands on a tower 80-100 meters tall. This wind turbine could produce 1.5 MW (1,500,000 watts)—enough electricity for about 400 US homes. Utility scale turbines keep getting bigger. Some turbines today can produce over 5 MW and have a rotor diameter of 126 meters!

The diameter of your blades is one of the major factors that determine the maximum power output of a turbine. Be wary of small wind turbines that promise very high power output. The laws of physics are rarely broken.

What is the Betz limit?

If you have been doing some research on wind turbines, you may have come across a term called the Betz limit.

Wind turbines are limited on how much power they can capture from the wind. These limits can be caused by generator efficiencies, blade design, friction in the drive train, but most importantly wind flow through and around the wind turbine. A wind turbine cannot capture 100% of the power in the wind, because that would mean that the wind would have to be stopped completely. For a turbine to work properly, some wind has to move out the back of the wind turbine and keep the blade spinning.

Albert Betz calculated that a perfect turbine could only extract 59.3% of power in the wind stream, and we now call this number the Betz limit.

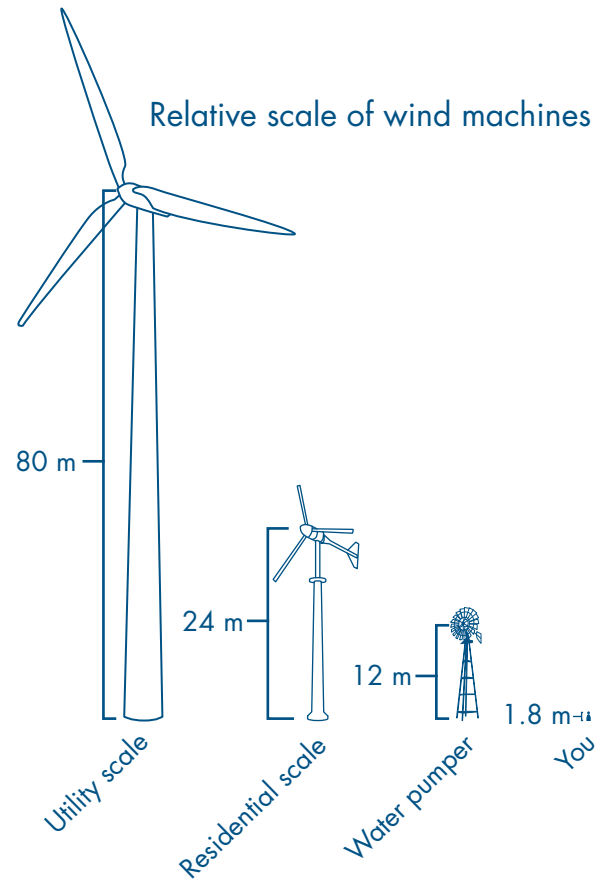
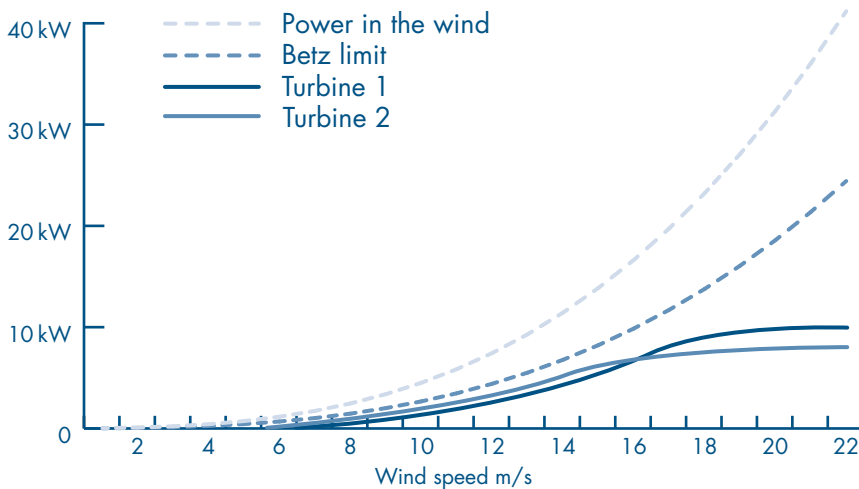

BETZ LIMIT IN PRACTICE

We have calculated the typical power in the wind coming from a box fan you may have around your house. We can compare that to how much power your turbine is producing to calculate your efficiency.

$$\text{Power in the wind} = \frac{1}{2} \rho (\pi r^2) v^3$$

$V = 5$ meters/second (typical fan output)

ρ (air density) = 1.0 kilograms/cubic meter

$r = .2$ meters

$A = .125 \text{ m}^2$ (area of circle = πr^2)

$$= (.5)(1.0)(.125)(5)^3$$

$$= 7.85 \text{ watts}$$

Based on these calculations there are 7.85 watts of available wind power coming out of a typical house fan on high.

Based on the Betz limit the best turbine we can produce will only capture is 4.65 watts ($7.85 \times 59.3\%$)

How many watts is your turbine producing? Are you generating 4.65 watts? If you are, give us a call—we have a job for you! Most KidWind turbines get around 10–15%!

More drag

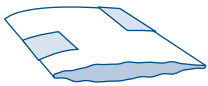

Less drag

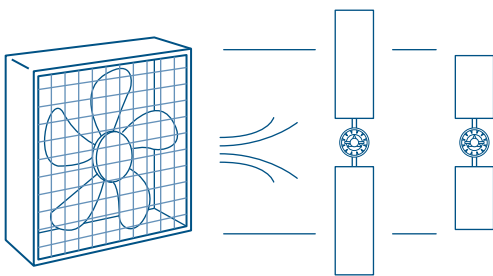
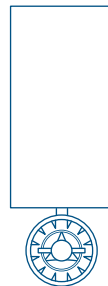
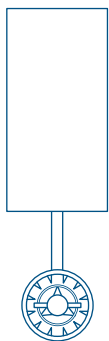
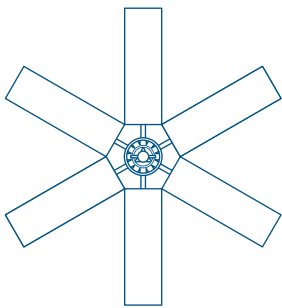

Blade pitch

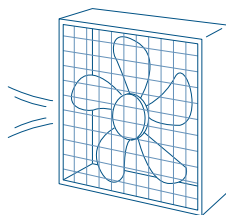
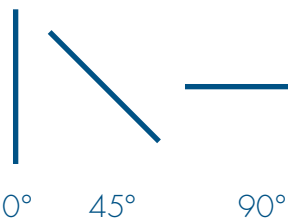

More power: Improve your blades

KidWind wind turbines are designed for use in science classes or as a hobby or science fair project. They were created to allow students a method to perform blade design experiments. Our turbines are not specifically designed to light bulbs, spin motors, or charge batteries, but they can if you have a good fan and manage to design efficient blades.

Having efficient blades is a key part of generating electricity from a wind turbine. Sloppy, poorly made blades will never make enough electricity to do anything. It takes time and thought to make good blades.

One thing you must always think about when making turbine blades is: "How much drag are my blades encountering?" Sure, your blades are probably catching the wind and helping to spin the hub and motor driveshaft, but could they be spinning faster? If they are adding drag, your whole system will slow down. In most cases, low RPM means less power output. The faster the blades spin, the more power you make!

Quick tips on improving blades

- Shorten blades: Many times, students make very long blades, thinking bigger is better. That is sometimes true, but students and teachers have a very hard time making long blades without adding drag. Try shortening them a few centimeters.
- Change the pitch: Often, students will set the angle of the blades to around 45° the first time they use the turbine. Try making the blades more perpendicular to the wind flow. Pitch dramatically affects power output. Play with it a bit and see what happens.
- Use fewer blades: To reduce drag, try using 2, 3, or 4 blades.
- Use lighter material: To reduce the weight of the blades, use less material or lighter material.
- Smooth surfaces: Smoother blade surfaces experience less drag. A blade with lots of tape and rough edges will have more drag.
- Get more wind: Make sure you are using a decently sized box or room fan, one with a diameter of at least 14"–18".
- Blades vs. fan: Are your blades bigger than your fan? This could be a problem, as the tips of your blades are not catching any wind and are just adding drag.
- Blade shape: Are the blade tips thin and narrow or wide and heavy? The tips travel much faster than the roots. Wide tips add drag.

Advanced blades

Two major forces act on wind turbine blades as they rotate: lift and drag. These forces are in constant competition. When you are optimizing wind turbine blades, try to maximize lift force but minimize drag force.

Wind turbine blades are airfoil shaped, much like airplane wings. This airfoil shape is designed to generate lift and minimize turbulence.

Lift is primarily produced as a result of the angle-of-attack of the blade. This angle creates a deflection force on the upwind side and a vacuum force on the downwind side of a wind turbine blade. The deflected air causes a reaction force that pushes the blade.

Turbine blades are tapered more at their tips and are also twisted slightly. Because of this twisted pitch, they have a greater angle-of-attack near their root where rotational velocity is slowest. Velocity is higher at the tip of the blade, so the angle-of-attack there is smaller. Turbine blades are designed in this manner to optimize the balance between lift and drag at all points on the blade.

Most real wind turbines use two or three blades. This configuration allows them to capture the most power with the least wind resistance. Using the fewest number of blades possible also reduces cost. The actual angle and taper of the blades depends on the anticipated wind speeds at the turbine's location.

KidWind blades

Flat blades create a great deal of torque, and therefore work well for weight-lifting experiments. Airfoil blades have less drag and can generate more power. You can make more sophisticated blades by giving them twisted pitch and an airfoil shape.

Ideas for constructing advanced blades

- Bend card stock into an airfoil shape. Glue a dowel inside the blade.
- Tape bent card stock to a flat piece of corrugated plastic or balsa wood to produce an airfoil shape.
- Take a block of foam and form it into an airfoil shape. Try to incorporate both a taper and a twist into the design.
- Carve and sand a piece of soft wood into an airfoil.
- Cut blades out of some form of cylinder. Try a cardboard tube, a paper or plastic cup, etc.
- Soak card stock in water for a few minutes. Form it into the desired shape and clamp or tape it in place until it dries and holds that shape.

Twisted Pitch

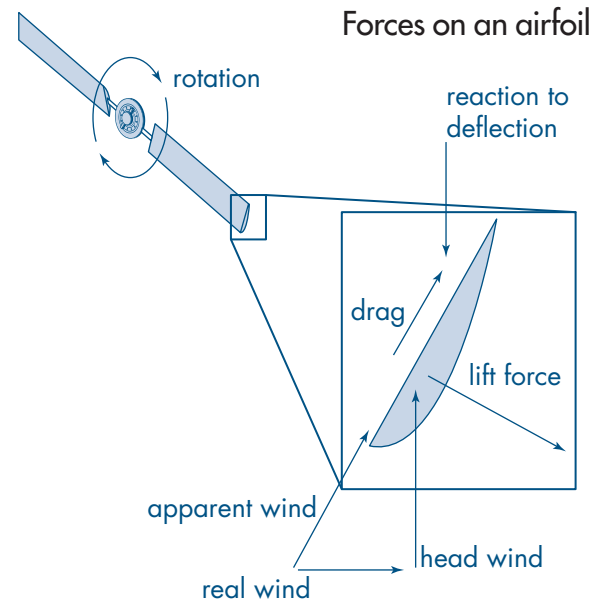
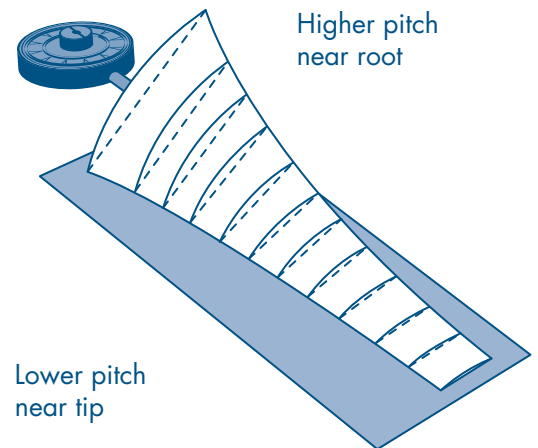

Using the KidWind Protractor

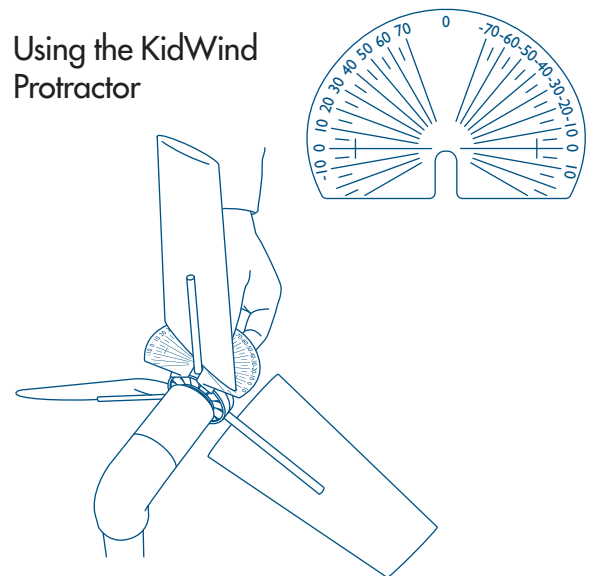

Further research

We always encourage students and teachers to continue learning about wind energy. There are some really great books, curriculum guides, articles, and websites out there (and more every day). We can't provide an exhaustive list of wind energy resources, but we put together a short list to help you get started.

View our full bibliography at www.KidWind.org/bibliography

Short list for teachers

Dobson, Clive. *Wind Power: 20 Projects to Make with Paper*. Buffalo, NY: Firefly Books, 2010.

Gipe, Paul. *Wind Energy Basics: A Guide to Small and Micro Wind Energy Systems*. White River Junction, VT: Chelsea Green Pub. Co., 1999.

Nemzer, Marilyn, and Deborah S. Page. *Energy for Keeps: Electricity from Renewable Energy: an Illustrated Guide for Everyone Who Uses Electricity*. Tiburon, CA: Tiburon Energy Education Group (aka Educators for the Environment), 2005.

Woelfle, Gretchen. *The Wind at Work: An Activity Guide to Windmills*. Chicago: Chicago Review Press, 1997.

Zubrowski, Bernie. *Wheels at Work: Building and Experimenting With Models of Machines* (Boston Children's Museum Activity Book). New York: Morrow, 1986.

Intermediate & advanced books

Overview

Boyle, Godfrey. ed. *Renewable Energy: Power for a Sustainable Future*. Oxford: Oxford University Press, 1996.

A comprehensive textbook look at all renewable energy. A solid technical source that is not too complicated.

Pasqualetti, Martin. et al. *Wind Power in View: Energy Landscapes in a Crowded World*. London: Academic Press, 2002.

Wind turbine siting is becoming a major issue; this book offers a discussion on the aesthetic impact of wind turbines.

History

Hills, Richard Leslie. *Power from the Wind*. Cambridge, England: Cambridge University Press, 1994.

A very detailed and thorough look at the history of wind power throughout the world since it was first invented.

Technical/engineering

Burton, Tony. et al. *Wind Energy Handbook*. West Sussex, England: John Wiley & Sons, 2001.

For the very curious, who want to delve deep into the aerodynamics of turbine blades, the mechanics of a turbine rotor, the electrical aspects of wind energy, wind turbine design, and the siting of wind farms. Be prepared for lots of math.

Gasch, Robert, and Jochen Twele. *Wind Power Plants: Fundamentals, Design, Construction and Operation*. Kent, England: Earthscan Publications Ltd., 2004.

Hansen, Martin O.L. *Aerodynamics of Wind Turbines*. Kent, England: Earthscan Publications Ltd., 2008.

This book is an essential text for fundamental solutions of efficient wind turbine design.

Hau, Erich. *Wind Turbines: Fundamentals, Technologies, Application and Economics*. 2nd ed. New York: Springer, 2006.

A technical look at wind power, but with less math than similar books of this kind.

Matthew, Sathyajith. *Wind Energy: Fundamentals, Resource Analysis and Economics*. New York: Springer, 2006.

Covers all major aspects of wind energy conversion technology. It discusses wind resource analysis and economic feasibility issues.

Websites

Curriculum resources

American Wind Energy Association Teacher's Guide for Grades 6–12 <http://learn.kidwind.org/bib/1>

Engineering is Elementary. Boston, MA: Museum of Science, 2011. <http://learn.kidwind.org/bib/2>

Catching the Wind: Designing Windmills is a great curriculum with activities related to the science and construction of windmills. The whole site has links to units that are designed for elementary teachers to teach engineering concepts.

Exploring Energy: Waterwheels, Windmills and Sunlight. Aries: Astronomy Based Physical Science. Watertown, MA : Charlesbridge Publishing, 2001. <http://learn.kidwind.org/bib/3>

Grades 3-6. Students investigate the concepts of energy and work.

KidWind Project. WindWise Education Curriculum. St. Paul, MN: Kidwind Project, 2010. www.WindWiseEducation.org
KidWind's own interdisciplinary wind curriculum and teacher training program. The lessons use scientific data and real life scenarios to help students think critically about wind energy. Grades 6–12.

National Renewable Energy Laboratory. <http://learn.kidwind.org/bib/4>

Wind with Miller. Denmark: Danish Wind Energy Association. <http://learn.kidwind.org/bib/5>

The "crash course" section is a great place to start for those who are new to wind energy. Also interactive activities.

Online video

NREL (National Renewable Energy Laboratory): <http://learn.kidwind.org/bib/6>

National Wind Technology Center Video Tour..

The Futures Channel—The Wind Business. <http://learn.kidwind.org/bib/7>

This excellent 6 minute video looks into wind turbine building issues (site research, construction, jobs, etc.).

US Department of Energy: Energy Efficiency and Renewable Energy—Wind and Hydropower Technologies Program. <http://learn.kidwind.org/bib/8>

Wind Turbine Animation shows how a wind turbine works.

Online interactivity

Centre for Alternative Energy. <http://learn.kidwind.org/bib/9>

Interactive site from England where you can explore the different parts of a wind turbine, look at wind farm sites and test electricity generation.

US Energy Information Administration: Energy Kids. <http://learn.kidwind.org/bib/10>

Interactive site for teachers and students.

US Energy Information Administration. <http://learn.kidwind.org/bib/11>

Quick and easy calculator to convert one energy unit to another.

Interactive Map of Offshore Wind: <http://learn.kidwind.org/bib/12>

Shows where wind projects are being planned and gives information about the stages of development.

National Geographic Wind Turbine Simulation: <http://learn.kidwind.org/bib/13>

This lets you experiment with a simulated wind turbine. Adjust the variables and see how many houses you can power!

Wind Powering America: <http://learn.kidwind.org/bib/14>

Explore small wind projects in the United States using an interactive map of the US.



800 Transfer Road, St. Paul, MN 55114
www.KidWind.org ♦ Phone: 877.917.0079
Fax: 208.485.9419

© Copyright 2012 All rights reserved