

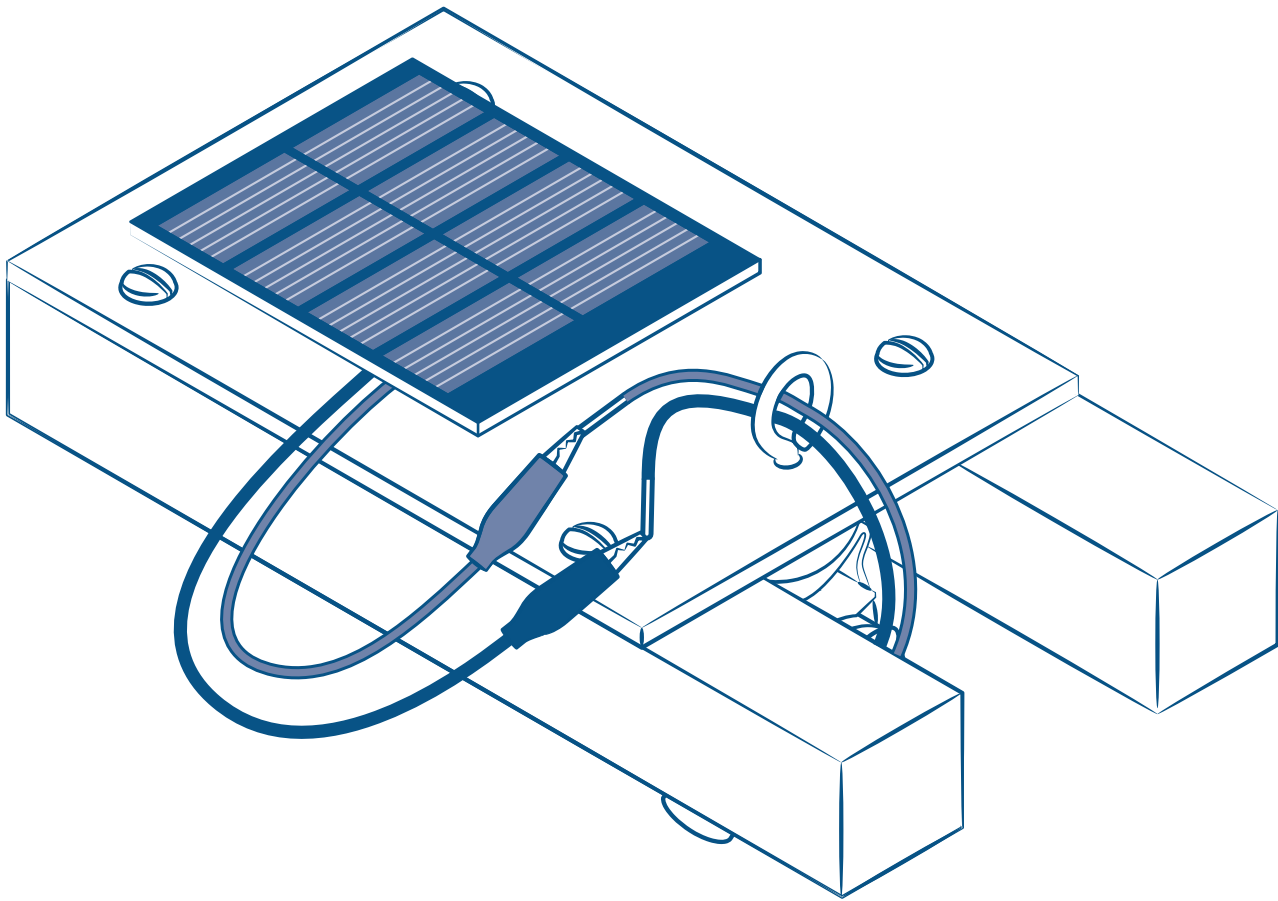

Solar Boat



About KidWind

The KidWind Project is a team of teachers, students, engineers, and practitioners exploring the science behind wind energy in classrooms around the US. Our goal is to introduce as many people as possible to the elegance of renewable energy through hands-on science activities which are challenging, engaging, and teach basic science principles.

While improving science education is our main goal, we also aim to help schools become important resources for both students and the general public, to learn about and see renewable energy in action.

Thanks to ...

We would like to thank the Wright Center for Science Education at Tufts University for giving us the time and space to develop this idea into a useful project for thousands of teachers.

We would also like to thank Trudy Forsyth at the National Wind Technology Center and Richard Michaud at the Boston Office of the Department of Energy for having the vision and foresight to help establish the KidWind Project in 2004. Lastly, we would like to thank all the teachers for their keen insight and feedback on making our kits and materials first rate!

Wind for All

At KidWind, we strongly believe that K–12 education is an important foundation for promoting a more robust understanding of the opportunities and challenges that emerging clean energy technologies present.

The Wind for All program seeks to support teachers and students all over the globe who do not have the financial capacity to access our training programs and equipment. We believe that all teachers and students—regardless of where they live or what school they attend—must be part of the clean energy future.

A Note on Reproduction

This work may not be reproduced by mechanical or electronic means without written permission from KidWind, except for educational uses by teachers in a classroom situation or a teacher training workshop. For permission to copy portions or all of this material for other purposes, such as for inclusion in other documents, please contact Michael Arquin at KidWind: michael@KidWind.org



Our plastic components are made from recycled resins.



We source domestically whenever possible, and assemble and pack our kits in St. Paul, MN.



Proceeds from your purchase help us train and supply teachers.

Parts

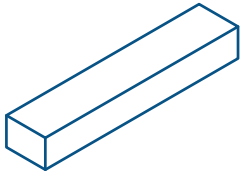

2

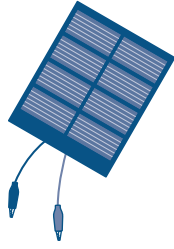

1

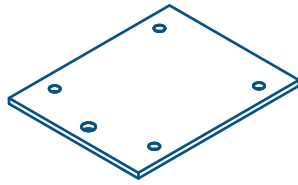

1

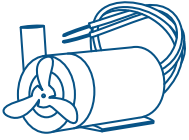

1



2



2



1



1



4



1

Solar Boat

Parts List

2 Balsa block 1" x 1" x 8"

1 Solar panel 2.0 V

1 Plywood 1/8" x 6" x 48"

1 Mini water pump, motor, & propeller

1 Conduit holder

2 Rubber bands

1 Wood ball

1 Eye bolt

4 Screw

1 Hex nut

How to Build the Solar Boat

1. Position the plywood deck over the balsa blocks with the edge of the deck all the way to one end of the blocks.
2. Push the screws through the deck holes and into the balsa pontoons (Fig 1).
3. Using a screw driver, very gently tighten the screws.
4. Assemble the motor mount. The eye-bolt goes through the deck, then through the wooden ball, then through the hole in the metal clip. Attach the nut to the eye-bolt threads and gently tighten (Fig 2).
5. Insert the motor with the propeller into the metal motor mount. To help secure the motor, wrap rubber band around the ends of the metal motor mount (Fig 3). The motor mount can be rotated to change the direction of the motor for fine adjustments, such as making the boat move straight, or in circles.
6. Thread the motor wires through the eye-bolt (Fig 4).
7. Place the solar panel on the deck.
8. Connect the solar panel to the motor using the clip cord ends of the solar panel wires (Fig 5). You can also screw the motor wires into the connections on the back of the solar panel. If the boat goes backwards, change the polarity of the wires (switch the black and red).
9. Place the solar panel on the deck to balance the weight of the boat. Now double check that everything on your boat is ship-shape! If so, take it outside to some water (or under a VERY bright light) and begin testing, experimenting, and racing your solar sea-faring vessel!

Tips

The sun has a lot more power than a light bulb, so experiment with your solar boat outside on a sunny day whenever possible. On a clear, sunny day, the average solar energy received by the earth is about 1,000 Watts per square meter. That means you would have to fit ten 100 Watt light bulbs in a 3 foot x 3 foot square to even come close to the power you can get from the sun!

When outside, use a pool or trough to test your boat. If you cannot find either of these, a trough can easily be made using four lengths of timber nailed or screwed in a rectangular shape. Drape builder's polyethylene or a pond liner into your wooden frame, fill it with water, and you're ready to go!

Please note: this Solar Boat is fine for periodic immersion in water. If you plan to use it a lot, however, you may want to paint or varnish the wood parts for maximum life.

Fig. 1

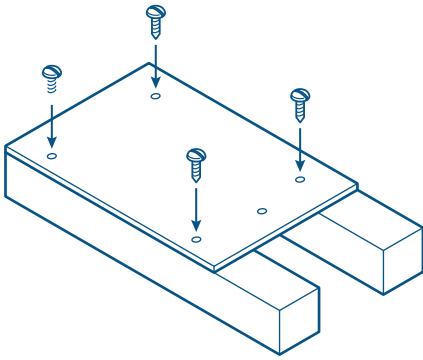

Fig. 2

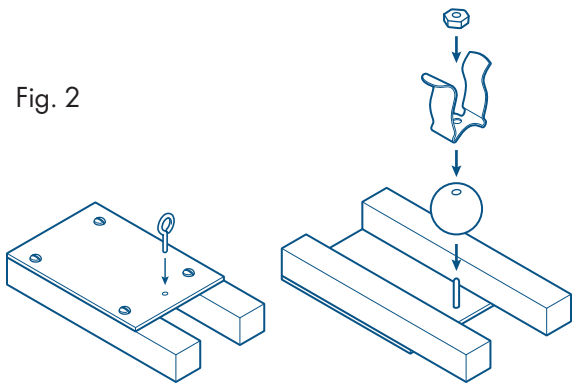

Fig. 3

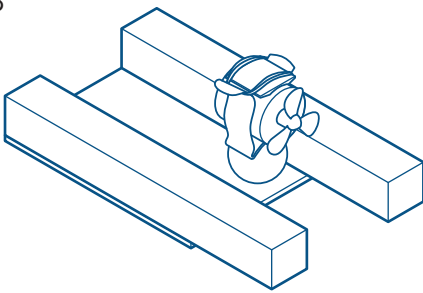

Fig. 4

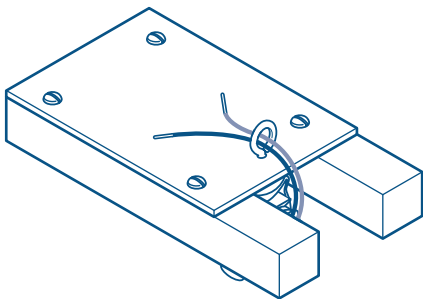
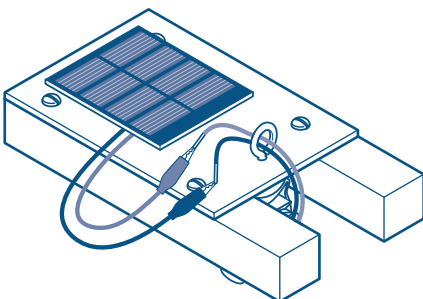

Fig. 5



Optimize your Solar Boat!

The most important aspect of a good boat is its ability to float in water! This ability is known as the buoyancy of a boat. In the 3rd century B.C., Archimedes discovered the law of buoyancy: "an object that is floating or immersed in a fluid experiences a buoyant force equal to the weight of the fluid the object displaces." Furthermore, it will displace a weight of water equal to the weight of the object. So, if you want your boat to float, more volume and less weight is best.

Drag

To create a fast and efficient boat, it is very important to minimize drag. Drag, (also called resistance) is the force that slows the movement of a solid object through a liquid or gas. Your boat will be moving through both a liquid (water) and a gas (air)!

Drag from water: The majority of the drag your boat experiences will come from the water, simply because water is so much thicker than air. The drag your boat experiences will vary depending on the speed of the boat.

To reduce drag, it is important to shape your hull very smoothly. A boat with a clean, gently sloping hull will have considerably less drag than a boat with jagged edges that produce turbulence in the water. A lighter boat will displace less water than a heavy boat. The more water you displace, the more drag your boat will create. Don't forget about the rudder! Though it will help you go straight, a poorly designed rudder will add a lot of drag.

Drag from the air: Air is much thinner than water, but it still has mass and density. If you are testing boats inside, you may not experience any detectable drag from the air. Outside, however, even slight winds can affect the speed and orientation of your boat.

Unless you are trying to harness the power of the wind (as in a sailboat), you will want to design your boat to minimize wind resistance.

Propulsion

If you want your boat to move forward, you must overcome the force of drag from the water and air. The spinning propeller will give the boat enough force to overcome this drag.

When the sun's rays activate the solar cell, an electric circuit is completed. The motor spins, turning the driveshaft and propeller with it. The spinning propeller creates a force that pushes water backwards. Newton's 3rd law tells us, "to every action there is an equal and opposite reaction." Therefore, the reaction force created by the propeller pushes your boat forward through the water!

Basic Experiments

Remember to use the scientific method when testing your solar boat! Hold other variables constant as you change and explore individual questions.

- Experiment with different propellers. Which propeller makes the boat go faster?
- What do you think would be more effective: a small propeller at high RPMs, or a larger propeller at low RPMs? Can you conclude anything about whether two blades or three blades would be better for a boat propeller?
- Try your boat with and without a rudder. What happens to a boat with no rudder?
- Does your boat go faster without the drag of the rudder? Can you make it go straight without using a rudder? Can you make it spin around in a circle?
- Adjust the angle of the solar panel. Try to get your solar panel to catch the most sunlight! Prop up the panel to change the angle. Use your protractor to measure this angle. What angle works best for you? Of course, you should take into account what direction your boat is facing, and what time of day you are testing.
- Experiment with different boat hull designs. How can you optimize your boat shape? Try different hulls; you can make a great hull out of two plastic drink bottles arranged next to each other. Use tape to mount the deck, motor, and driveshaft on top of your bottle boat. Also try cutting a 2-liter bottle in half (the long way) to make a classic boat shape. Be creative, and try to come up with the best boat design you can. What factors make a better boat?

What is Solar energy? How does it work?

Every day, the sun sends out an enormous amount of energy. It radiates more energy in one second than the world has used since time began! This radiant energy, also known as solar energy, is vital to us because it provides the world directly—or indirectly—with almost all of its energy. In addition to providing the energy that sustains the world, solar energy is stored in fossil fuels and biomass, and is responsible for powering the water cycle and producing wind!

Solar energy comes from within the sun itself. Like other stars, the sun is a big ball of gases, mostly hydrogen and helium. The hydrogen atoms in the sun's core combine to form helium and radiant energy in a process called *nuclear fusion*. This process creates a large amount of radiant energy, which is emitted into space. Only a small portion of the energy radiated by the sun into space strikes the earth, one part in two billion. Yet this amount of energy is enormous. Every day, enough energy strikes the United States to supply the nation's energy needs for one and a half years!

Solar energy is considered a renewable energy source. Renewable sources of energy are resources that are continually renewed by nature, and hence will never run out. Solar power is considered renewable because the nuclear (fusion) reactions that power the sun are expected to keep generating sunlight for many billions of years to come.

Solar Electricity and Photovoltaic Systems

Solar energy can also be used to make electricity. This is done largely through the use of photovoltaic (or PV) systems. Photovoltaic comes from the words photo, meaning light, and volt, a measurement of electricity. Photovoltaic cells are often called solar cells. They convert light directly into electricity.

The photovoltaic effect is the basic physical process through which a PV cell converts sunlight directly into electricity. PV technology works any time the sun is shining, but more electricity is produced when the light is more intense and when it is striking the PV modules directly when the rays of sunlight are perpendicular to the PV modules.

Sunlight is composed of photons, or bundles of radiant energy. When photons strike a PV cell, they may be reflected or absorbed, or transmitted through the cell. Only the absorbed photons generate electricity. When the photons are absorbed, the energy of the photons is transferred to electrons in the atoms of the solar cell.

With their newfound energy, the electrons are able to escape from their normal positions associated with their atoms to become part of the current in an electrical circuit. By leaving their positions, the electrons cause holes to form in the atomic structure of the cell into which other electrons can move.

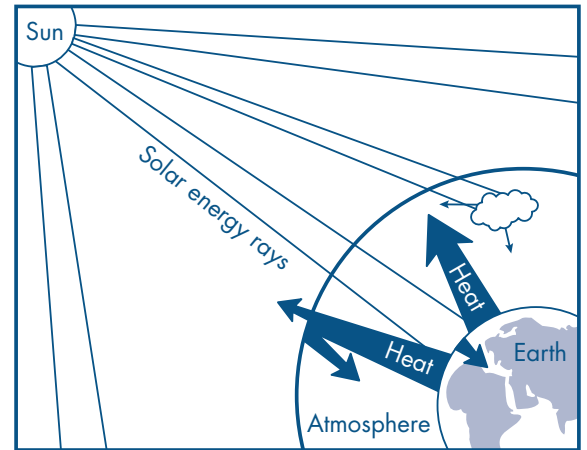

The Greenhouse Effect

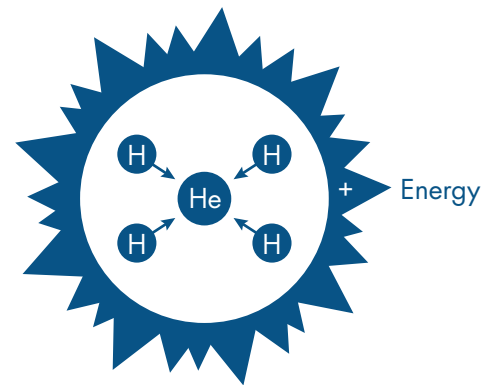

Nuclear Fusion

PHOTOVOLTAIC CELL CROSS SECTION

- ⊕ = proton ⊖ = tightly-held electron
- = free electron ○ = can accept an electron

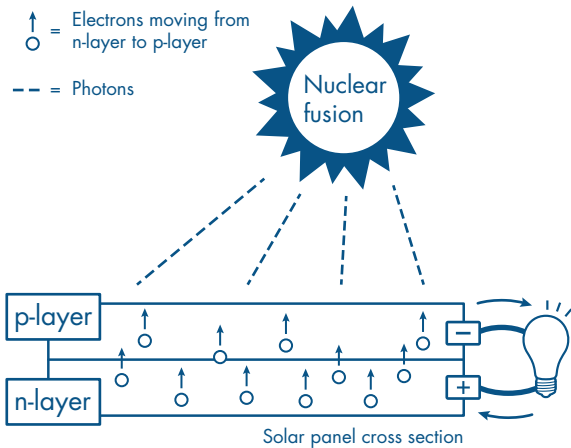
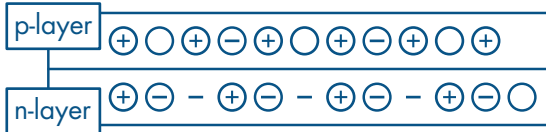

Excited electrons flow through the silicon semiconductor from the N-Layer to the P-Layer. They flow out the negative terminal, through the circuit, and back to the positive terminal. When a load is attached, the electrons are forced to do work (i.e. light a bulb).

Solar cells are usually made of two thin pieces of silicon, the substance that makes up sand and the second most common substance on earth. Silicon is used because it is a semiconductor, or a solid that is in between a conductor and an insulator of electricity. One piece of silicon has a small amount of boron added to it, which gives it a tendency to attract electrons. It is called the P-Layer because of its positive tendency. The other piece of silicon has a small amount of phosphorous added to it, giving it an excess of free electrons. This is called the N-Layer because it has a tendency to give up negatively charged electrons. When the two pieces of silicon are placed together, some electrons from the N-Layer flow to the P-Layer and an electric field forms between the layers. The P-Layer now has a negative charge and the N-Layer has a positive charge.

When the PV cell is placed in the sun, the radiant energy energizes the free electrons. If a circuit is made connecting the layers, electrons flow from the N-Layer through the wire to the P-Layer. The PV cell is producing electricity—the flow of electrons. If a load such as a light bulb is placed along the wire, the electricity will do work as it flows.

Compared to other ways of producing electricity, PV systems are expensive. This is mainly because PV cells require silicon that is extremely pure. This level of purity makes the silicon expensive. However, despite the high cost, PV systems have many useful applications and their demand is growing rapidly.



Solar panel

Resources

For more information, check out these great resources on solar energy!

The NEED Project (www.Need.org)

<http://www.need.org/needpdf/Photovoltaics%20Student%20Guide.pdf>

<http://www.need.org/needpdf/ExploringSolarStudent.pdf>

The United States DOE Office of Energy Efficiency and Renewable Energy

<http://www1.eere.energy.gov/kids/roofus/>

http://www.eere.energy.gov/basics/renewable_energy/photovoltaics.html

Other cool sites

www.solarschoolhouse.org/

<http://www.solar4rschools.org/>

americansolarchallenge.org/

www.worldsolarchallenge.org/

<http://www.energyquest.ca.gov/story/chapter15.html>

<http://science.howstuffworks.com/environmental/energy/solar-cell.htm>

<http://www.schoolgen.co.nz/se/>

<http://solardat.uoregon.edu/SunChartProgram.html>

Solar Boats

<http://original.solar-active.com/boat.htm>

<http://www.members.iinet.net.au/~gveale/solar/>



800 Transfer Road, Suite 30B, St. Paul, MN 55114
www.kidwind.org ♦ Phone: 877.917.0079
Fax: 208.485.9419

© Copyright 2013 All rights reserved