

Materials for
1 Solar Scavenger Hunt
or 1-3 Students



Grades

- 4-12

Time required

- Two 45 minute class periods

Concepts

- Inquiry and science process
- Energy and energy transformation
- Using basic tools
- Collecting and interpreting quantitative and qualitative data

Objectives

At the end of the lesson, students will:

- Understand and be comfortable with basic electrical concepts and terminology
- Know the fundamental aspects of a solar panel and understand how placement and orientation affect its power output
- Be able to use a multimeter to measure voltage and amperage in order to collect data
- Use the scientific method to isolate and understand solar panel variables
- Build teamwork skills during the investigation and experiment process

Your REcharge Labs Kit

The materials enclosed in this kit will help you bring engaging lessons about renewable energy into your classroom. Consider attending a REcharge Lab workshop, if you haven't already done so, to enhance your experience using these materials.

About REcharge

We believe that responsible and informed students of today will become our innovative renewable energy leaders of tomorrow. At REcharge, our mission is to provide the resources to encourage this generation of informed thinkers, involved doers, and curious life-long learners.

REcharge offers a series of professional development workshops for K-12 educators, called REcharge Labs. Our Labs are designed to give educators the knowledge and tools to help K-12 students build connections between science, technology, engineering, art, and math concepts and the social and environmental issues related to renewable energy. All Labs meet a variety of educational standards, including National Standards and Next Generation Science Standards.

REcharge was born out of programming from the KidWind Project, and relies upon KidWind's resources and history to carry out its work. KidWind has been a leader in renewable energy education for over a decade. REcharge, like KidWind, continues to be committed to bringing affordable, hands-on applications of our materials to teachers and students worldwide.

A note on reproduction

Reproduction of this activity guide and associated kit is prohibited except for student use in the classroom. For permission to copy portions or all of this material for other purposes, please contact REcharge Labs at info@rechargelabs.org.

Find kits and sign up for teacher trainings at www.rechargelabs.org



Materials

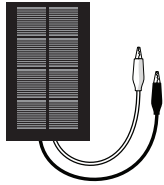

Solar panel
(2V 400mA)

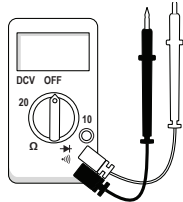

Multimeter

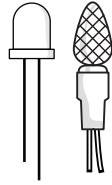

Assorted
LEDs

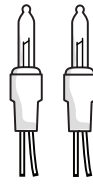

Assorted
incandescent
bulbs

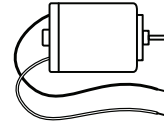

Solar motor



Pair of
clamp wires

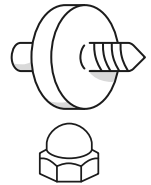

Screw hub
and acorn
nut

You will need to supply the following materials:

- Pencil
- Tape measurer
- Wire stripper
- Small Phillips head screw driver (for the teacher only)
- Adjustable table lamp that can handle 150 watt or higher incandescent bulb
- 150 watt or higher incandescent bulb
- Protractor
- Print out of the Solar Scavenger Hunt Kit worksheet (page 19)

Bonus materials to supply:

- Compact fluorescent bulb for lamp
- LED bulb for lamp

Background

Photovoltaic (PV) technology goes back as early as 1839, when a nineteen-year-old French physicist, Alexandre Edmond Becquerel observed a light-electricity conversion phenomenon during his experiments. From there, many contributors, some including Nikola Tesla, Albert Einstein, Bell Labs, Western Electric, and NASA, aided in the research, development, and advancement of photovoltaic technology. Early PV arrays in 1958 were used to power radios on US Vanguard space satellite! Currently China is the leader in the manufacturing solar panels, with Canada and US far behind. Based on data collected in 2014, the countries leading in installed PV capacity in order by production are Germany, China, (rest of) Europe, Japan, Italy, and the US.

Learning Goals

Students will learn about some of the main variables that determine what can be powered by a solar panel. Solar panels can be hard to understand, as they appear to be powering things but it's not clear how and why they work. By gathering both quantitative and qualitative information, students will get a better idea of how solar panels work, where they work best, and what variables affect their productivity. Students will use a tool called a multimeter to read the exact voltage and amperage of a solar panel, which will help them measure, understand, and compare the information they gather during the hunt.

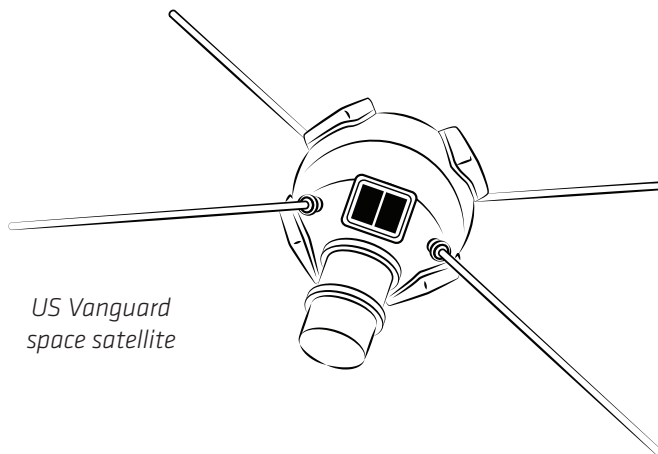

*US Vanguard
space satellite*

Getting Ready

- Go on a test Scavenger Hunt! This is useful in knowing what light sources are available within the Scavenger Hunt parameters. It is also helpful in testing things out to make sure they work.
- Brush up on your circuitry knowledge, as students will have questions.
- Gather the tools and any additional items students will need to complete the activity.
- Practice using the multimeter, following instructions on pages 12-13.
- Set up the lamp with the high wattage bulb on a work table. Keep it off until the students are ready.
- Parts of this activity are best done outside on a sunny day, although they can be done indoors using other light sources. If outside is not an option, make sure you set up high wattage lamps in the activity area, with 150 watt or more incandescent bulbs. For best performance indoors, lamp lights need to be within 4"-8" from the solar panel.

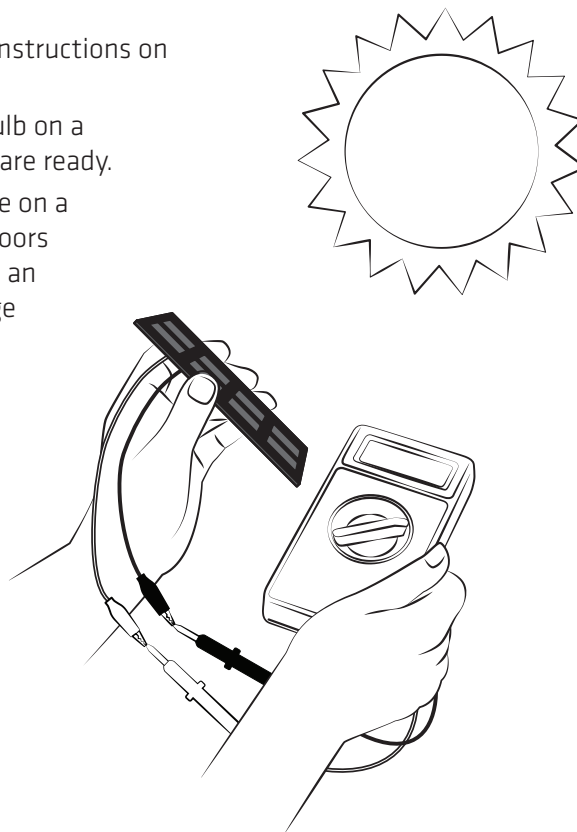

Activity Overview

This is a step-by-step activity guide that will take two 45 minute class periods to complete. During the first class period, students will learn about solar panels and use them, and during the second they will learn how to measure their results. An extension is provided as an additional activity to use for longer class periods, or for older students.

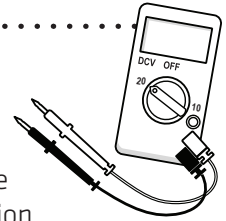

CLASS PERIOD 1

Understanding loads, light sources, connecting loads in series and parallel, and polarity.

Step 1: Beginning questions for students

- How many light sources can you identify? What are some of the qualities of the difference light sources?
- Have you seen a solar panel before? How do you think a solar panel works?
- What do you think affects how much energy the solar panel produces?

Step 2: Distribute materials

Organize students into groups of 1-3. Each group of students will need: two LEDs, two incandescent lights, a motor, a solar panel, and a wire stripper.

Step 3: Identify solar panel and loads

Have students take turns looking at the materials. Understanding the parts of these objects will help students understand how they work!

Solar panel: The correct term for this item is PV (photovoltaic) module, but because it's common name is solar panel, that is the term used in

the guidebook. A solar panel is made up of tiny photovoltaic (PV) cells. Photovoltaic comes from the words photo, meaning light, and volt, the measurement of electricity. Solar panels transform radiant energy (light) into electrical energy, which can be used to power a load. Because solar panels require light to generate electricity, the intensity and the angle of the light affects how much electricity can be generated. Features: There are two wires, one red (+) and one black (-) attached to the panel by screws,

Fig. A

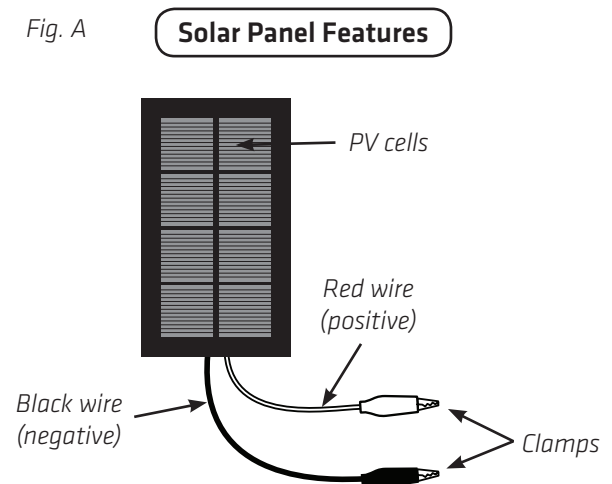

with clamps on the opposite ends (Fig. A). Solar panels are a direct current (DC) circuit, meaning, one pole is always negative, the other pole is always positive, and the electrons only flow in the direction of negative to positive.

Load: A load is work the power source has to do. Some loads are more difficult to power than others. Think of the loads as weights. Some may be easy to lift because they are light, and some may more difficult to lift because they are heavy. In order to lift heavy loads with a solar panel, more electricity needs to be generated with a stronger light source, connecting additional solar panels, or reducing the load. Listed below are the load options included in the kit.

LED bulb: The LEDs in the kit have a crystal ball shape and two wires coming out of them.



LED bulb

Incandescent bulb: The incandescent bulbs have a fluted glass top and two wires coming out of them.



Incandescent bulb

Motor: A motor transforms electrical energy (from the solar panel) into mechanical energy, and spins a shaft. Features: This motor is a DC circuit, and has a red (+) and black (-) wire (Fig.B).

Motor moving an object: The motor can lift weight or spin something using the Screw Hub (the red piece) and the acorn nut. The Screw Hub fits on

Fig. B

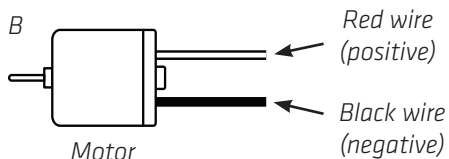

the motor shaft and the acorn nut on the screw. A piece of thread or a piece of cardboard can be secured between the Screw Hub and acorn nut. Adding weight increases the load (Fig. C).

Fig. C

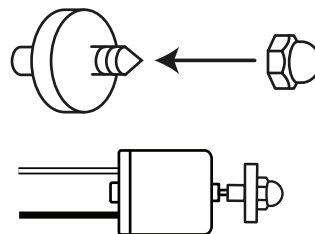

Multiple loads hooked together

A solar panel can power more than one load depending on how much electricity is generated and how much power each load requires. Now that we have identified the basic components, we can move on to getting them ready to be tested and hooked up into a circuit (Fig. D).

Fig. D

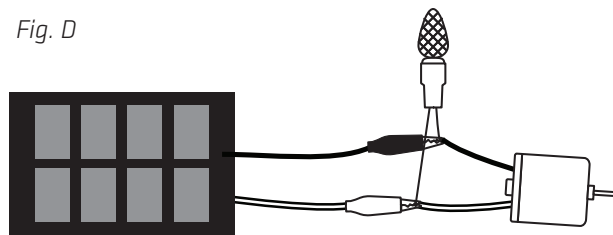

Step 4: Practice stripping wire

Using the following steps, have students take turns using a wire stripper to strip 1/4" inch of the rubber coating off the wires of the LEDs, incandescents, and motor (Fig. E). Practice first on the lights, and do the motor last. Squeeze the wire stripper gently around the rubber coated wire, scoring the rubber all around. Pull the rubber off the wire, and it should easily slide off. If not,

cut deeper. Don't cut too deep or the tool will just cut through the wire! The exposed wire is often threaded, meaning it has many strands of copper wire in it. If the small copper wires get frayed while stripping, twist the frayed wires together.

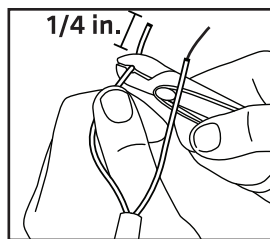

Fig. E

Step 5. Use the solar panel to test loads

Before the students go on their scavenger hunt, give a brief overview of how to use a solar panel to test loads.

- Attach clamp wires to the exposed wires of the load (not the plastic wire coating), with the solar panel pointing towards the light source (Fig. F)
- When testing the LED, if it doesn't work with the wires attached to the panel one way, flip it around and try it with the opposite wires (Fig. G). This is because LEDs are polarity sensitive, so the direction of electron flow matters.

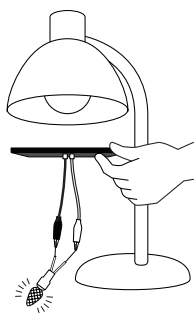

Fig. F

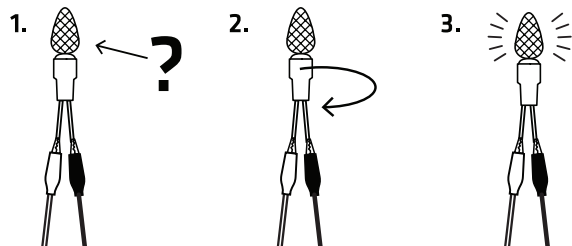

Fig. G

Step 6: Attach loads in series and parallel

A solar panel can run multiple loads at a time depending on the type of load, how many loads there are, how they are connected, and the light available. While still at their tables, have students practice attaching their loads in series and parallel circuits. Test under the lamp at the table to see if their connections are working.

Attaching two incandescent bulbs in series:

Connect one leg of the incandescent bulb to the leg of another. The other legs connect to the solar panel. This connection is a series circuit. Think of it as people holding hands in a line (Fig. H).

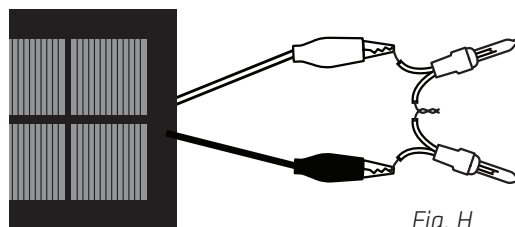

Fig. H

Light two LEDs in series:

Have the students try hooking up the LEDs in series. Regardless of how they attach the legs in series, keeping in mind the polarity, LEDs will not light up in series unless a much higher voltage runs through them.

Light two LEDs in parallel:

Another type of connection is called a parallel circuit. In a parallel circuit the positive wires from both LEDs are connected to the positive wire of the solar panel, and the negative wires from both LEDs are connected to the negative wire of the panel. LEDs work well in a parallel circuit (Fig. I).

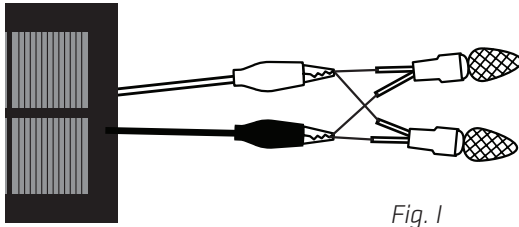

Fig. I

Attaching the motor to a series or parallel circuit:

The motor can be added to any series or parallel circuit like the lights (Fig. J).

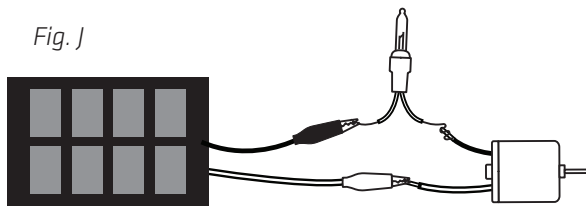

Fig. J

Step 7: Test solar panel variables

While in groups, have the students initiate the Scavenger Hunt by attaching the solar panel to one of the LED bulbs, then going in the sun (or under a lamp) to test and see what factors get the best performance from the solar panel. Make sure they have all the loads available and switch them out to see if there is a difference.

Variables to be tested:

- Angle of solar panel to the light source
- Type of load attached
- Time of day if in the sun, or type light source

As students are testing their solar panels with different variables, watch what they are figuring out. There may be some troubleshooting you can help with, refer to the tips below.

Step 8: Recap

Once the time is up, call them back to their tables. Ask them the following questions:

- How does an LED light work with a solar panel compared to an incandescent?
- Did anyone get the motor to work? How did that happen?
- What did you find out about the solar panel and the light sources?
- What did not work?

TROUBLESHOOTING THE SOLAR PANEL:

- Check the connections between the solar panel and load, and make sure they are attached properly.
- Make sure the solar panel is directly facing the light source, and there are no shadows or objects (including fingers!) blocking the panel.
- Move the solar panel closer to the light. Be aware that if you are too close to a hot lamp, you may burn yourself or the panel.
- The light source may not be strong enough; move on to test different kind.
- If the solar panel is left under a lamp and gets hot, it's ability to produce electricity will be significantly less than in its room temperature condition. Cool the panel off and its production should return to normal.
- Check the wire terminals on the back of the solar panel. Where the wires are screwed into the panel, make sure the wires are still secure. If they have fallen out, screw them back in. If the wire has been broken off, use a wire stripper to strip off 1/4 " of the wire,

twist the copper threads, and screw in the wire to the terminal.

- Make sure there are no short circuits. A short circuit is an important safety issue to bring up with students. It is easy to prevent, but a short circuit will probably happen at least once during the activity. A short circuit occurs when two conductive parts are touching within a circuit, causing a path of very low resistance (Fig. K). When a short circuit occurs, the load stops working, and the power source will start to get hot! Unlike a battery pack-which can get dangerously hot instantly, the small solar panel provided takes a while to get hot in a short circuit, and is not as dangerous. Regardless, short circuits still need to be watched out for and prevented.

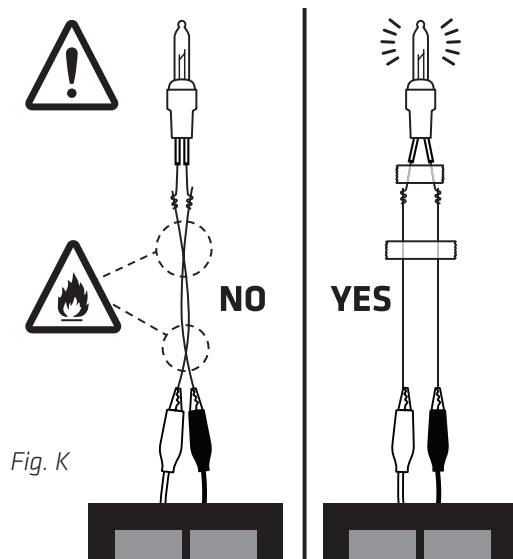

Step 9: Clean up

Time to clean up. Disconnect the solar panel from the loads, and the loads from each other.

Optional reading for homework

Understanding how a solar panel produces electricity is important in knowing why it works! Have students do the brief reading on page 18 or find additional resources that will help them understand.



CLASS PERIOD 2

Collecting data, using a multimeter, understanding voltage and amperage.

Getting ready:

Set up the lamp with the high wattage bulb on a work table. Keep it off until the students are ready.

Step 1: Introduce the Scavenger Hunt

For the Solar Scavenger Hunt, students will be documenting and experimenting with variables that affect a solar panel's ability to generate electricity. Hand out the Solar Scavenger Hunt Worksheet (page 19). They will record the data they collect on this worksheet.

Step 2: Identify the Solar Scavenger Hunt variables in the worksheet

- Solar panel variables
- Light source (described below)
- Distance from the light source
- Angle of the panel to the light source

Light source variables

Type of light source: There are different light sources in the world, both natural and human-made. Human-made sources, like light bulbs, come in a variety of sizes, brightnesses, and types. There may be different types of lights located within the classroom, for example: fluorescent, incandescent, LED.

Wattage (Watts): This is often printed on light bulbs, and indicates the intensity of light. A 120 watt bulb is brighter than a 60 watt bulb.

Step 3: Understand polarity, voltage, and amperage

Write polarity, voltage, and amperage on a board. Give the students a couple minutes within their groups to figure out what the terms mean. Record their definitions on the board.

Polarity

Designates the way electrons flow through any circuit: from negative to positive. Polarity is symbolized as a (+) or (-) sign, or with the colors red and black, respectively.

Voltage

Voltage is the amount of potential energy between two points on a circuit. V is the symbol for voltage.

Amperage (amps)

Amps measure electrical current. A is the symbol for amps. Amps are important because they are the easiest way to distinguish the strength or capacity of a power source.

What is the difference between voltage and amperage?

Think of it this way: electricity flowing through a wire is like water flowing through a garden hose. The amount of water that can fit through the hose depends on the diameter of the hose (amps). The pressure of the water depends on how open the faucet is (volts).

Voltage and amperage will make more sense as students use a multimeter to explore how different light sources affect the voltage and amperage output of a solar panel, and how loads require specific rates of each in order to do work.

Step 4: Assign roles for the hunt

This activity is best done in groups of 1-3 students because of the number of parts to hold onto and measure at once. Each role is equally important, and each member of the group must work closely together. If there are fewer than three in the group, roles can be combined.

Roles for each group member:

1: Holding the solar panel and protractor

2: Holding the multimeter

3: Doing measurements, measuring the data, and recording on the Scavenger Hunt Data Sheet



Step 5: Distribute materials

Each group will get a multimeter, solar panel, protractor, tape measurer, a pencil, and a copy of the Solar Scavenger Hunt worksheet (page 19).

Step 6: Introduce the Solar Scavenger Hunt worksheet to collect data

Before each group scatters, take a moment to assign roles, demonstrate how to use a

multimeter, and have them identify different light sources as a class. Encourage students to think about indoor and outdoor options. What are the different types of light bulbs? Also prompt them to think about how additional variables affect the lights, such as colors, reflective surfaces, shade, or through windows. What might different angles and distances from the light source do to the solar panel's effectiveness?

On the Solar Scavenger Hunt worksheet, they will:

- Choose and record at least three light sources to test
- Choose and record at least three distances to test for the light sources
- Choose and record at least three angles to test for the solar panel

Step 7: Practice using a multimeter

Since we cannot see energy flowing through a wire or the voltage of a solar panel, we must use measurement tools like multimeters to visualize what is happening with the charge in a system.

Multimeters are tools that measure voltage and short circuit amperage, among other things related to circuits. The data is displayed as numbers giving an exact quantitative value to the connection being tested. A multimeter is the tool that will help us see what is happening within a solar panel.

Measuring the potential voltage of a solar panel

Turn on the table lamp. At their tables, have the students connect their multimeter to the solar panel, with their panel below the lamp, then turn the meter to the position shown in the direct

current (DC) range (Fig. L). What numbers are they getting? This number represents the voltage from the solar panel. Still at their tables, ask the students: do the numbers change if they move the panel around?

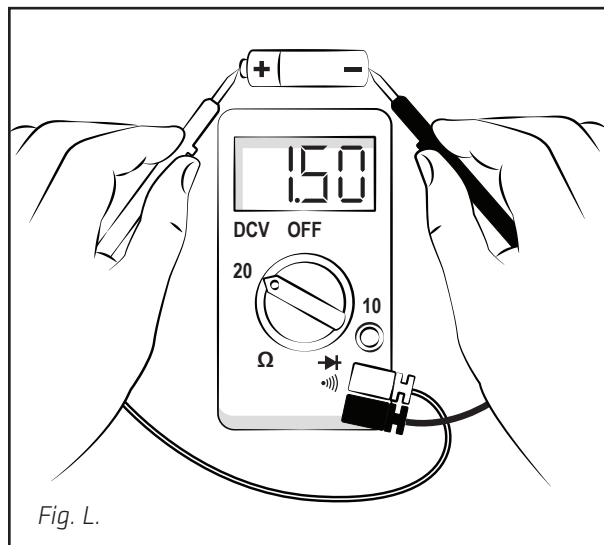

Measuring the short circuit amperage of a solar panel

Ask students to use a multimeter to see the potential short circuit amperage reading from the solar panel. Students should set the meter to the position shown in the diagram; notice the positive probe is plugged into a different hole on the meter (Fig. M). This position will allow us to read short circuit amps. In the 10 A setting, the multimeter should be reading somewhere around .01 - .50 Amps (1/100th - 1/2 an amp) or 10-500 milliamps for a single solar panel.

Why is this called “short circuit amperage” instead

of amperage? To test current in the measurement of amperage there needs to be a load. The solar panel needs to do work in order to know it's potential of how much work it can do! In order to take an amperage reading, inside the multimeter is a measured load in the form of a resistor. Because of the way the solar panel is hooked up to the multimeter, and the small quantity of the load within, it is practically a short circuit, and the measurement is just potential, not actual amperage.

Fig. M.

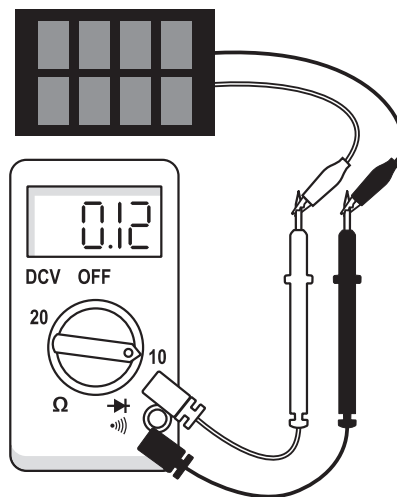

SAFETY WARNING!

To avoid electrocution, do not use the multimeter to touch anything that is attached to wall power, or any outlets. Additionally, multimeter probes can be pointy! Be careful not to poke or scratch with them.

Step 8: Go on the scavenger hunt!

Using the techniques they've learned to measure voltage and amperage on the lamp, have students go out and test other light sources. Allow 10-20 minutes for students to gather data on their worksheet. Remind them to fill in for each light source: type and wattage (if known), distance, angle, voltage, and amperage.

Step 9: Evaluate the data

Afterwards, reconvene as a class to discuss the data gathered. A larger version of the worksheet can be projected and filled in, or a chart can be drawn on the board, and the students can come up and fill in their data.

Questions

Ask students to reflect on the data, and within their groups discuss these questions:

- Was there light source that had a high voltage but low amperage? Reflecting on the previous hunt with the loads, how does this match up?
- Which areas are the best places to place solar panels? Why?
- What conclusion can be drawn from the data gathered with the multimeter and the testing done previously with the loads?

Step 10: Clean up

Shut off the lamps, make sure the multimeter is turned in the off position, detach the solar panel, and return all the tools.

Extension Activity

Hooking solar panels in series and parallel

In this activity, students will learn how to connect multiple solar panels, and understand how panels in series or parallel can affect output.

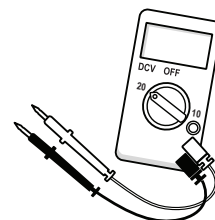

Prepare

At least two solar panels are required to do this extension. Set up the lamp with the high wattage bulb at a work table. One lamp per group.

Step 1. Form groups

Form groups of 1-3 students, and have them sit around a table with a lamp.

Step 2: Distribute materials

Hand out more solar panels if you have extras, or combine groups so that they can share two panels. Each group should get a multimeter, two LEDs, two incandescents, one motor, and two solar panels.

Step 3: Connect the panels

Turn on the table lamp. To start, have students use the multimeter to read the short circuit amperage and voltage of a single solar panel under the lamp light. They should take note of the numbers they are getting. Then, they should connect the two panels in series, clipping the red wire to the black wire (Fig. N). Using the multimeter, they should measure both amperage and voltage, noting what happens to those numbers. How did that change from the numbers

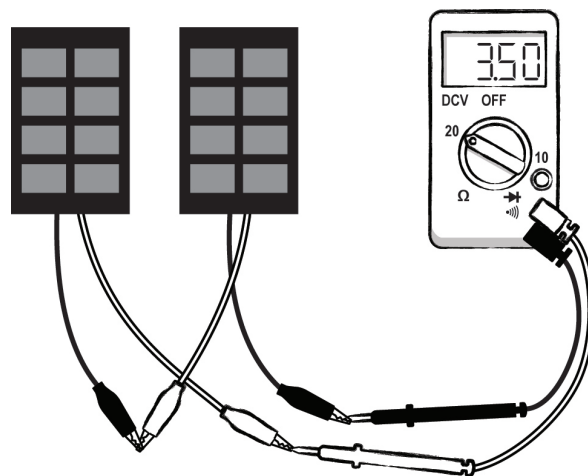

Fig. N

Wired in series

they got from the single panel? Now, have them connect the two in parallel, clipping the red to red wire and black to black wire (Fig. O). Using the multimeter, they should again measure amperage and voltage and note the changes. Students should be getting approximately double the voltage when they hook up two solar panels in series, but still around the same value for amperage. When the two panels are in parallel, the amperage should almost double, while voltage remains around the same.

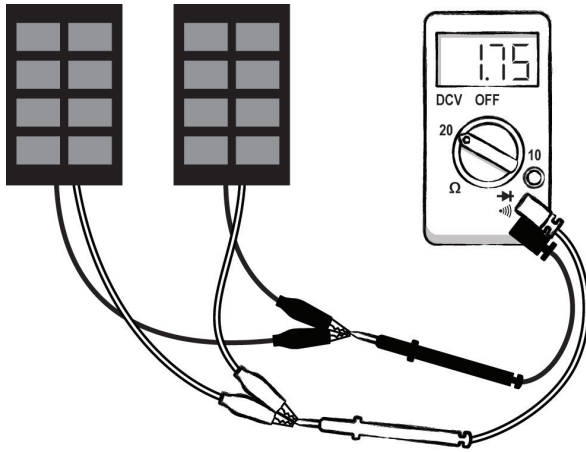

Fig. 0

Wired in parallel

Step 4: Attach the loads

Using what they learned about the amperage and voltage differences of panel arrangement, have students connect their arrangement of choice to a single load, or multiple loads in series or parallel. Does this have the effect they anticipated? If not, they should switch it to the other panel arrangement and see if that makes a difference. What arrangement of solar panels was able to turn on all the loads really well?

Vocabulary

We have listed some important vocabulary terms for students to understand as they work through the activities.

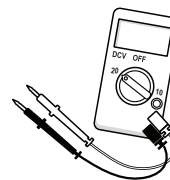

load

The work the power source has to do.

polarity

Designates the way electrons flow through any circuit - from negative to positive. Polarity is symbolized as a (+) or (-) sign, or red and black, respectively.

direct current (DC) circuit

A circuit in which one pole is always negative, the other pole is always positive, and the electrons flow from negative to positive.

voltage (V)

The amount of potential energy between two points on a circuit.

amperage (amps)

A measure of the current of a circuit, or the amount of electricity used.

series circuit

A circuit in which components are connected in a single path, like hands being held. In series, voltage changes and current remains consistent throughout.

parallel circuit

A circuit in which components are connected in parallel lines, like tracks on a railroad line. In parallel, current changes and voltage remains consistent throughout.

solar panel

Otherwise known as a photovoltaic module, comes from the words photo, meaning light, and volt, the measurement of electricity. A solar panel transforms radiant energy (light) into electrical energy.

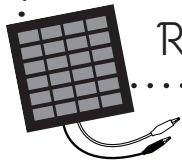

Reading: How Does a Solar Panel Work?

Given how prevalent solar panels are, it's surprising how little most people understand them. Give your students a brief overview of the process that happens inside each solar panel. Find a video or a diagram to supplement, this will give them a more tangible understanding of how this can be used as an energy source.

Each solar panel is made up of tiny photovoltaic (PV) cells. Photovoltaic comes from the words photo, meaning light, and volt, the measurement of electricity. They convert light directly into electricity. PV technology works any time the sun is shining, but the most electricity is produced when the light is intense and when sunlight is striking the PV modules at a perpendicular angle, which is the most direct.

Sunlight is composed of photons, or bundles of radiant energy. When photons strike a PV cell, a fraction of them are absorbed, and the energy from these photons is transferred to electrons in the atoms of the solar cell. With their newfound energy, the electrons are able to escape from their normal positions associated with their atoms to become part of the current in an electrical circuit. By leaving their positions, the electrons cause holes to form in the atomic structure of the cell into which other electrons can move, continuing the process.

Solar cells are usually made of two thin pieces of silicon, a semiconductor. One piece of silicon

has a small amount of boron added to it, which gives it a tendency to attract electrons. It is called the P-Layer because of its positive tendency. The other piece of silicon has a small amount of phosphorous added to it, giving it an excess

- ⊕ Protein
- ⊖ Tightly-held electron
- Free electron
- Can accept an electron

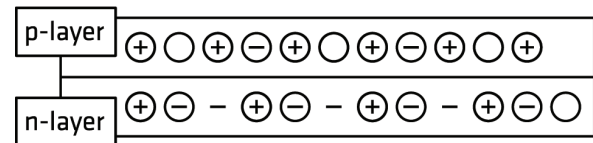

PHOTOVOLTAIC CELL CROSS SECTION

of free electrons. This is called the N-Layer because it has a tendency to give up negatively charged electrons. When the two pieces of silicon are placed together, some electrons from the N-Layer flow to the P-Layer and an electric field forms between the layers. The P-Layer now has a negative charge and the N-Layer has a positive charge. When the PV cell is placed in the sun, the radiant energy energizes the free electrons. A circuit is made connecting the layers, forcing electrons to flow from the N-Layer through the wire to the P-Layer. The flow of electrons means the PV cell is now producing electricity!

Solar Scavenger Hunt Worksheet

Using your knowledge of solar panels, go on a Solar Scavenger Hunt to find where the solar panel produces the most power and where it produces the least. Think about different sources of light, or using the same source of light at different distances, different angles, and through or against different types of surfaces.

LIGHT SOURCE	DISTANCE FROM LIGHT SOURCE	ANGLE TO LIGHT SOURCE	MULTIMETER READING



Did you like the **Solar Scavenger Hunt Kit**? Then you might be interested in these REcharge Labs classroom kits.

Solar Cork Boat Class Pack

Have your class build and float their own solar powered boats! From speed boats to large double decker paddle boats, this class pack is a hands-on lesson in solar power, geared versus direct drive, buoyancy, balance, load, and paddle wheel design.

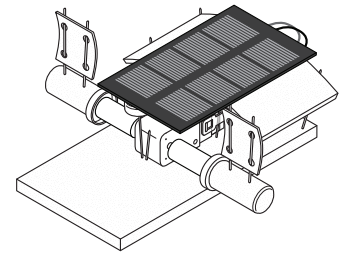

Firefly

For kids of all ages, discovering wind energy using the firefly™ is easy, fun, and affordable. The firefly is a small turbine designed to light an LED when placed in the path of the wind. Also comes with the option to design and test your own blades.

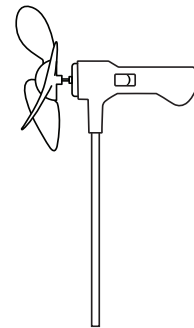

Solar Fountain Kit

Learn how to use the power of the sun to build a creative electrical fountain. Discover how solar panels work, learn basic circuitry, and use this knowledge to build a custom solar powered fountain.

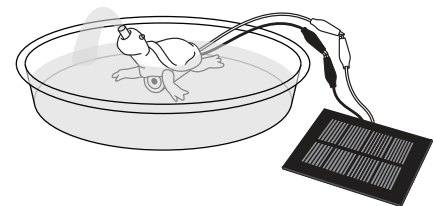

Visit www.rechargelabs.org for more.

2010 E Hennepin Ave, Building 2, Suite 101, Box 51, Minneapolis, MN 55413
Phone: 877-917-0079 | Fax: 208-485-9419 | Email: info@rechargelabs.org

© REcharge Labs 2016 All Rights Reserved